



# Profiles & Trims Catalog

## 2023

Take Your Design to the Edge™



**LATICRETE offers a comprehensive line of profiles and trims including a broad range of materials, finishes and colors in a multitude of shapes and sizes, making it easy to find the right product for the job. German-engineered and manufactured, LATICRETE® Profiles & Trims meet the highest quality of standards to ensure the best installation experience and final appearance for years to come.**



Installation Systems .....	4 - 5
LATICRETE Portfolio .....	6 - 7
Warranties .....	8
Customer Support/Social Media .....	10
Technical Training and Seminars .....	11



**TILE PROFILES**  
12 - 39

L-Shape Edge Profiles .....	13 - 18
Finishing Profiles .....	19
Square Edge Profiles .....	20 - 25
Round Edge Profiles .....	26 - 36
Decorative Border Profiles .....	37
Cove Profiles .....	38
T-Shape Profiles .....	39



**STAIR NOSING PROFILES /  
TRANSITION PROFILES**  
40 - 43

Stair Nosing Profiles .....	41
Transition Profiles .....	42 - 43



**SKIRTING PROFILES**  
44 - 45

Skirting Profiles .....	45
-------------------------	----

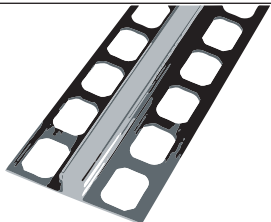

**EXPANSION JOINT  
PROFILES**  
46 - 49

Thin-Bed Profiles .....	47 - 49
-------------------------	---------



**INFORMATION**  
50 - 55

Part Number Explanation & Codes .....	50 - 51
Maintenance for Tile Profiles .....	52
Service Terms .....	53 - 55



Icon indicates profile with corresponding LATICRETE grout color.



Additional Profiles & Trims available at [laticrete.com/profiles](http://laticrete.com/profiles).

# One Source. Limitless Capabilities.

## From Profiles to the Complete LATICRETE® System.

LATICRETE offers you a comprehensive line of profiles and trims for edging, nosing, and transitions on the market. For use with a variety of finishes, including tile and stone, terrazzo, wood, LVT and more. Install them indoors and outdoors, in kitchens and bathrooms, commercial and residential applications, and everything in between. You can even create unique design elements and accent colors using our selection of LED profiles.

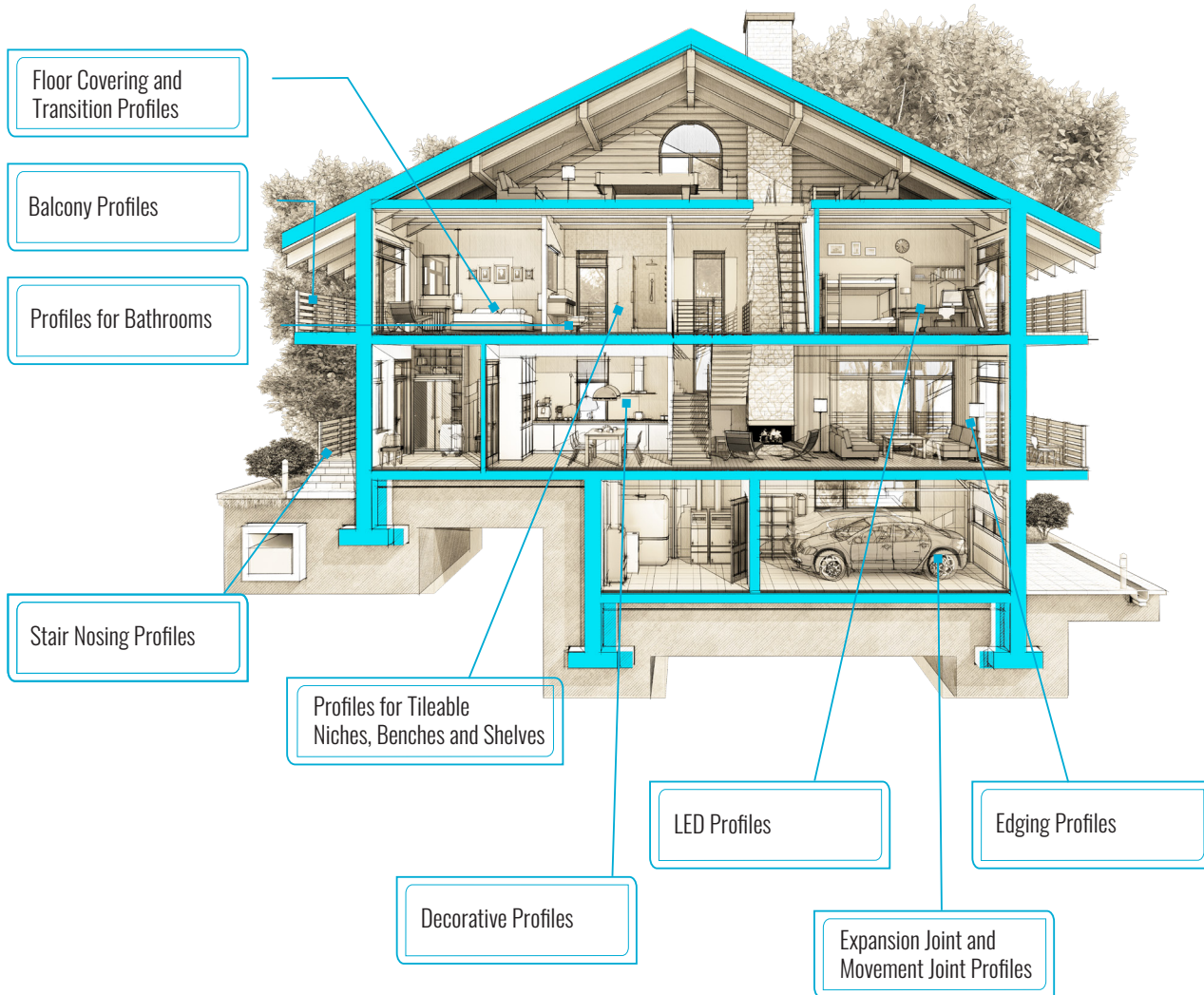

# LATICRETE offers a complete system solution for virtually every tile and stone application.

For more than half a century architects, engineers, and developers have trusted LATICRETE with their tile and stone installation needs. Let our experience, product quality, and technical support assist you on your next project — whatever the application.

LATICRETE has successfully provided the technology for innovative, permanent installations of tile and stone finishes.

Architecturally specified and preferred by professional installers, LATICRETE provides solutions for virtually every application.

- LATICRETE® products are industry accepted, code approved, and backed by 100% labor and materials system warranties, thereby assuring a successful installation each and every time
- LATICRETE membranes, adhesives, grouts, and sealants are weather-resistant and freeze/thaw stable when cured

## SOUND CONTROL AND ANTI-FRACTURE

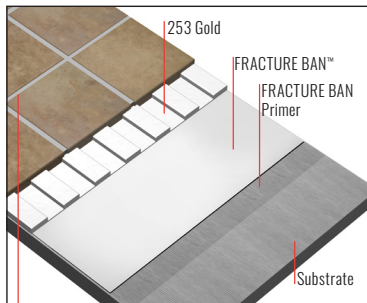

SPECTRALOCK® PRO Premium Grout† or PERMACOLOR® Select^

## WALLS AND FACADES

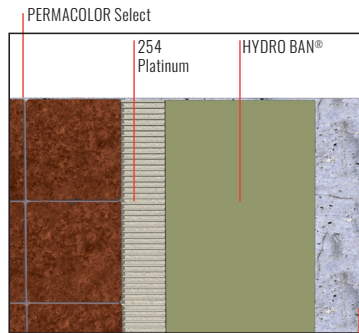

Properly prepared concrete, backer board, or masonry substrates (if substrate requires leveling, use 3701 Fortified Mortar)

## PREFORMED SHOWER

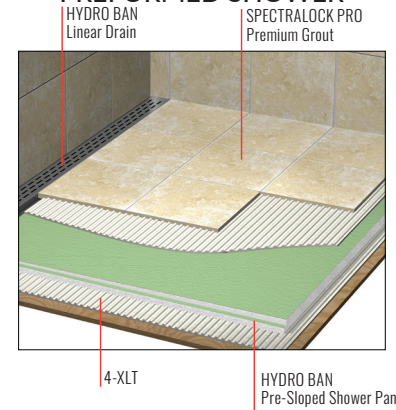

## COMMERCIAL AND INDUSTRIAL FLOORS AND WALLS

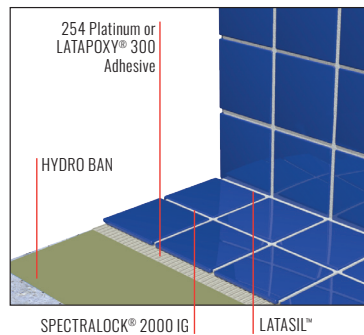

## WET AREAS AND CONTINUOUS UNDERWATER SUBMERSION

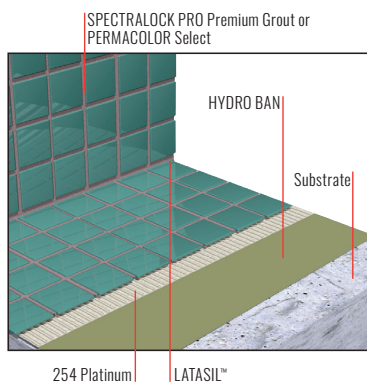

## PLAZA & DECK

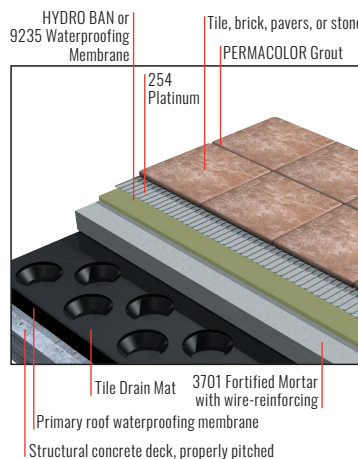

## UNCOUPLING MAT

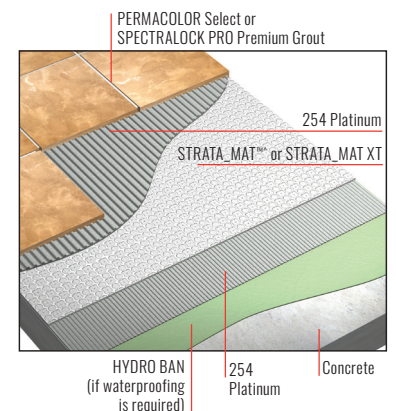

Consult our website at [laticrete.com](http://laticrete.com) for the most current versions of product data sheets, warranties, and SDS sheets. Content of this brochure is for informational purposes only. Refer to individual product data sheets and warranties for complete information. ^United States Patent No.: 6,784,229 B2 (and other Patents). †United States Patent No.: 6,881,768 (and other Patents). ‡NOTE: Not available for sale in Canada.

For over 65 years, LATICRETE has led the industry with pioneering advancements — developing high-performance building materials for architects and construction professionals worldwide. From time-tested to ground-breaking, our broad product portfolio provides superior quality and value. We are fully committed to innovation, growth, and a complete system component approach.



## Tile & Stone Installation Systems

Ensure a successful installation each and every time with the most comprehensive assortment of innovative tile and stone installation materials available worldwide. LATICRETE® industry-leading products provide complete system solutions from the substrate up through the grout for virtually any type of tile or stone installation in commercial, industrial, and residential applications.

Product categories include surface preparation, waterproofing, shower system components, sound control, anti-fracture, floor warming, adhesive mortars and grouts — all designed to work together, providing a comprehensive installation.

CSI Division 9

## Profiles & Trims

Whether a sleek, modern look or a more traditional design is desired, LATICRETE Profiles & Trims offer the flexibility and versatility to achieve those results in commercial and residential applications.

Available in aluminum, stainless steel, brass, and PVC, LATICRETE Profiles & Trims are each crafted with the utmost precision, milled with state-of-the-art equipment, and produced with the finest raw materials to create premium-quality and a consistent appearance piece to piece.

LATICRETE profiles and trims can protect tile edges and enhance safety all while providing a finishing touch to any room. The comprehensive line includes expansion joints, corner protection, stair nosing, edging, and balconies — and is compatible with tile, carpet, vinyl, wood, and more.

## Tile, Stone & Surface Care

Over time, daily use and foot traffic can significantly impact surface appearance and result in permanent damage. Routine care and maintenance with the right products can make all the difference to ensure a beautiful lasting surface.

LATICRETE® STONETECH® is a line of reliable and high performing surface care solutions designed to clean, protect, restore and enhance stone, tile, masonry and grout. Highly effective at preventing oil, water and stain damage, STONETECH offers natural look sealers that protect porous surfaces but do not alter the surface appearance and enhancing sealers that can revive the color or finish all while protecting. STONETECH cleaners ranging from daily to heavy duty and problem solving solutions will eliminate everyday spills and restore the appearance without harming the intended surface. Preserve the beauty of stone, tile, and grout with STONETECH.

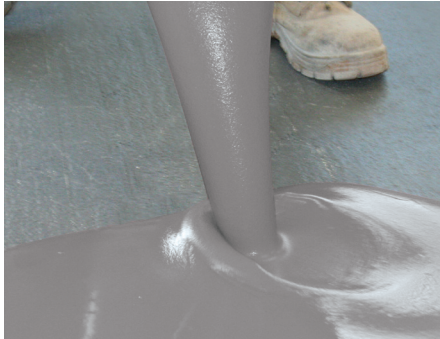

## Concrete & Substrate Preparation

A quality finished floor starts with a properly prepared surface—one that guarantees a long-lasting, durable installation. LATICRETE time-tested surface preparation products are formulated to preserve quality by protecting installations from water vapor transmission, sound transmission, and cracks. They provide a perfectly level substrate to accommodate a variety of floor finishes including vinyl, wood, carpet, and tile.

Our innovative products are engineered to ensure substrates will easily accept finishes with minimal time and maximum cost-effectiveness, no matter how challenging your subflooring project may be.

CSI Divisions 3 & 9



## Adhered Façade & Wall Finish Systems

Keep up with the increasing popularity of adhered masonry veneers. Trust your installations to a complete productivity-boosting system designed to deliver superior, long-term performance on masonry projects of all types including residential, commercial, and industrial applications.

Unlike traditional methods and materials, the Masonry Veneer Installation System (MVIS™) is engineered to provide a permanent, high-strength installation that uses a revolutionary waterproofing membrane. The MVIS is designed for thin-brick, manufactured stone and natural stone veneers for interior and exterior applications. Complementary products include sealers and cleaners for stone and pavers.

CSI Divisions 4 & 7



## Resinous Coating & Floor Finish Systems

Offer unparalleled integral colors, textures, and finishes with high-performance coatings, overlayments, and restoration solutions that give owners exceptionally attractive, durable, decorative floors. LATICRETE decorative finishes allow you to deliver vivid color and gloss with high impact and wear resistance, quick turnaround, and low maintenance.

CSI Divisions 3 & 9

## Industry-Leading Training and Support

### UL GREENGUARD Gold Certification

LATICRETE® low-VOC products are independently certified. Our products help you contribute toward LEED certification.



### LEED Support

Our online project certification tool automatically generates required LATICRETE product information for your specific LEED project submittals. Additional LEED information and calculations are available at [laticrete.ecoscorecard.com](http://laticrete.ecoscorecard.com).



### LATICRETE Architectural Guidebook

Use this informative online tool to get complete specifications and details for your projects. You can access it at: [www.laticrete.com/ag](http://www.laticrete.com/ag)

### Training and Education

LATICRETE Training Classes and Continuing Education Classes are available through various platforms. Check our website regularly for the latest offerings and updates at: [www.laticrete.com/training](http://www.laticrete.com/training).

# LATICRETE offers the best system warranties in the industry.

## Unmatched Peace of Mind

LATICRETE takes pride in delivering comprehensive system warranty packages and superior service through industry-leading support. With training from our highly experienced technical support team and quick, easy access to supportive online tools, we provide everything you need to ensure high-performance solutions.



<b>Lifetime System Warranty</b> See Data Sheet 230.99 for complete warranty information.	
APPLICATION	PRODUCTS
<b>Profiles &amp; Trims</b>	Stainless Steel
<b>Underlayment</b>	NXT® Primer NXT Level Plus
<b>Floor Warming<sup>^</sup></b>	STRATA_HEAT™ WIRE STRATA_HEAT Mat STRATA_HEAT Thermal Packs 4-XLT with STRATA_HEAT Thermal Packs
<b>Waterproofing/ Anti-Fracture</b>	HYDRO BAN® HYDRO BAN CEMENTITIOUS Waterproofing Membrane HYDRO BAN Sheet Membrane 9235 Waterproofing Membrane HYDRO BAN Quick Cure Waterproofing Membrane
<b>Shower System</b>	HYDRO BAN Pre-Sloped Shower Pan (and applicable accessories) HYDRO BAN Linear Pre-Sloped Shower Pan (and applicable accessories) HYDRO BAN Linear Drain HYDRO BAN Bonding Flange Drain HYDRO BAN Drain Cover, HYDRO BAN Board HYDRO BAN Board Screws HYDRO BAN Board Tab Washer
<b>Uncoupling</b>	STRATA_MAT™ <sup>^</sup> , STRAT_MAT XT
<b>Thick Bed Mortar</b>	HYDRO BAN Quick Cure Mortar Bed 3701 Fortified Mortar
<b>Slurry Bond Coat</b>	254 Platinum
<b>Thin Bed Method</b>	257 TITANIUM™ 254 Platinum (regular or rapid version) MULTIMAX™ Lite - United States Patent No. 6784229 (and other Patents) 255 MULTIMAX United States Patent No. 6784229 (and other Patents) LATAPOXY® 300 Adhesive LATAPOXY BIOGREEN 300
<b>Multipurpose Bonding Primer</b>	PRIME-N-BOND™
<b>Grout</b>	SPECTRALOCK® PRO Premium Grout United States Invention Patent No. 6881768 (and other Patents) SPECTRALOCK PRO Grout United States Invention Patent No. 6881768 (and other Patents) PERMACOLOR® Grout United States Patent No. 6784229 (and other Patents) PERMACOLOR Select United States Patent No. 6784229 (and other Patents)
<b>Sealant<sup>†</sup></b>	LATASIL™ LATASIL 9118 Primer

10 and 5 Year System Warranties also available.  
See Data Sheet 30.10 and 230.05 for complete warranty information.



<b>25 Year System Warranty</b> See Data Sheet 025.0 for complete warranty information.	
APPLICATION	PRODUCTS
<b>Profiles &amp; Trims</b>	Stainless Steel, Aluminum, Brass
<b>Underlayment</b>	NXT Primer NXT Level Plus
<b>Floor Warming<sup>^</sup></b>	STRATA_HEAT WIRE STRATA_HEAT STRATA_HEAT Thermal Packs 4-XLT with STRATA_HEAT Thermal Packs
<b>Vapor Reduction</b>	NXT Vapor Reduction Coating SPARTACOTE™ Moisture Vapor Barrier
<b>Waterproofing/ Anti-Fracture</b>	HYDRO BAN HYDRO BAN Sheet Membrane 9235 Waterproofing Membrane LATAPOXY Waterproof Flashing Mortar HYDRO BAN QUICK CURE HYDRO BAN CEMENTITIOUS Waterproofing Membrane
<b>Exterior Veneer Waterproofing/Anti-Fracture</b>	MVIS™ Air & Water Barrier LATAPOXY Waterproof Flashing Mortar
<b>Shower System</b>	HYDRO BAN Pre-Sloped Shower Pan (and applicable accessories) HYDRO BAN Linear Pre-Sloped Shower Pan (and applicable accessories) HYDRO BAN Linear Drain HYDRO BAN Bonding Flange Drain HYDRO BAN Drain Cover, HYDRO BAN Board HYDRO BAN Board Screws HYDRO BAN Board Tab Washer
<b>Sound Control/Anti-Fracture</b>	125 Sound & Crack Adhesive 170 Sound & Crack Isolation Mat Fracture Ban 40, 90 and Fracture Ban Primer
<b>Plaza &amp; Deck</b>	Plaza and Deck System
<b>Uncoupling</b>	STRATA_MAT, STRATA_MAT XT
<b>Thick Bed Method</b>	Quick Cure Mortar Bed 3701 Fortified Mortar MVIS Premium Mortar Bed
<b>Slurry Bond Coat</b>	254 Platinum
<b>Thin Bed/Adhesive Method</b>	257 TITANIUM 254 Platinum (regular or rapid version) 255 MULTIMAX United States Invention Patent No. 6784229 (and other Patents) MULTIMAX Lite United States Invention Patent No. 6784229 (and other Patents) LATAPOXY 300 Adhesive LATAPOXY BIOGREEN 300 TRI-LITE™ Glass Tile Adhesive MVIS Hi-Bond Veneer Mortar (regular or rapid version) MVIS Veneer Mortar MVIS Thin Brick Mortar MVIS Lightweight Mortar
<b>Multipurpose Bonding Primer</b>	PRIME-N-BOND
<b>Spot Bonding</b>	LATAPOXY 310 Stone Adhesive—Standard and Rapid Grade
<b>Grouting/Pointing</b>	SPECTRALOCK PRO Premium Grout (non-industrial applications) United States Invention Patent No. 6881768 (and other Patents) SPECTRALOCK PRO Grout (non-industrial applications) United States Invention Patent No. 6881768 (and other Patents) PERMACOLOR Grout United States Patent No. 6784229 (and other Patents) PERMACOLOR Select /PERMACOLOR Select NS United States Patent No. 6784229 (and other Patents) MVIS Premium Pointing Mortar MVIS Pointing Mortar
<b>Sealant<sup>†</sup></b>	LATASIL LATASIL 9118 Primer





# LATICRETE provides you with online access to the latest in sales and marketing tools.

Simply visit [www.laticrete.com](http://www.laticrete.com) to download the latest LATICRETE marketing support tools, and technical design manuals or request a hard copy at [www.laticrete.com/tools](http://www.laticrete.com/tools).



Social Media  
 Like and Follow LATICRETE on social media and...  
 Be the first to know about product announcements  
 Hear the latest industry news  
 Discover installation tips  
 Find product training near you  
 Win great swag

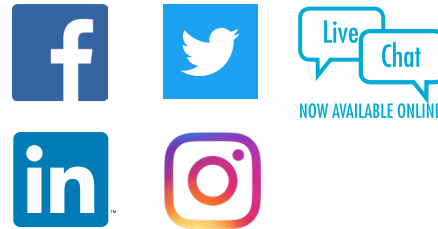

Follow us on Facebook, Twitter, LinkedIn, Instagram

<p><b>PRODUCT AND PROCESS</b></p>	<p><b>CONTRACTORS</b></p>	<p><b>DISTRIBUTORS</b></p>
<p><b>INDUSTRY</b></p>		
<p><b>DESIGNERS</b></p>	<p><b>CHARITABLE</b></p>	<p><b>GREEN</b></p>

## Learn industry standards from experts in the field and from the comfort of your home or office.

LATICRETE offers intensive training programs that were specifically developed for industry distributors, dealers and other industry professionals. Programs are offered through multiple platforms:

- LATICRETE Profit Through Knowledge (PTK) classes held at LATICRETE Technical Training Centers throughout the US (in person training classes through LATICRETE Technical Services)
- LATICRETE Profit Through Knowledge Webinars
- LATICRETE Connectados & Connectados PLUS Global Training Webinars
- LATICRETE University
- LATICRETE Product Knowledge (PK) seminars are available locally through your LATICRETE Technical Sales Representatives. Contact your local LATICRETE Technical Sales Representative for additional information.

Check [www.laticrete.com/training](http://www.laticrete.com/training) for more information.

### BENEFITS

- Expand knowledge of how to select and recommend the most suitable installation materials
- Increase knowledge of LATICRETE® products
- Learn trade definitions, performance requirements, and industry standards
- Learn how to solve and avoid job problems
- Participate in hands-on product demonstrations

### SEMINAR LOCATION

LATICRETE Technical Training Centers are located throughout the US at various LATICRETE office locations. Check our website regularly for class information and locations.

### PROGRAM INCLUDES

Tile, Stone, Masonry Veneer Installation Systems, Resinous Flooring, Surface Preparation and Construction Chemical

industry installation methodology and respective LATICRETE Product knowledge installation training conducted by the LATICRETE Technical Services Department. Experienced instructors use classroom instruction, hands-on product demonstrations and virtual tools to provide the latest LATICRETE installation and product training.

### LEARN ONLINE AT YOUR LEISURE

LATICRETE is proud to announce its new eLearning program, LATICRETE UNIVERSITY.

LATICRETE UNIVERSITY makes it possible for anyone within the industry to train on industry standards and Profit Through Knowledge (PTK) Technical Seminars from the comfort of their home or office. Training has become necessary to learn about new products and modern technology. Traveling and leaving your business behind to attend training is not always easy or possible. Now anyone in your company can receive the quality information, previously possible only during live training sessions, within a short period of time and without leaving the job for an extended period of time.

LATICRETE UNIVERSITY presents vital industry and product information in short, easy segments that can be taken at any time, 24/7.

Here's how it works:

1. You listen to and observe a short tutorial.
2. You take a short test that will measure your knowledge retention.
3. Upon the successful completion of a segment, you print a certificate or have it emailed to you for your employee training records.

Note – You can pause and resume your training at any time. You can re-take training to sharpen your knowledge.

To access the LATICRETE UNIVERSITY, go to [www.laticrete.com/training](http://www.laticrete.com/training), create a user profile and begin your training.



For further information, log onto [www.laticrete.com/training](http://www.laticrete.com/training), or contact LATICRETE at +1.203.393.0010, ext. 1235





## TILE PROFILES

PAGE 12 - 39

**Tile profiles are designed to protect and visually enhance any finished tiled floor, wall and countertop. Ranging from multiple decorative shaped edges to coves, borders, transitions and more, LATICRETE® tile profiles come in many different materials, finishes and colors that can create a unique, sharp look to any room. The design possibilities are endless.**

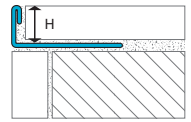

L-SHAPE EDGE PROFILES MADE OF STAINLESS STEEL 304

Height (in)	Height (mm)	Item Number	Price Each
Length: 8' 2-1/2" (2.5 m)			
1/8	3.0	LS5-E030GLO-01	\$22.63
3/16	4.5	LS5-E045GLO-01	\$26.76
1/4	6.0	LS5-E060GLO-01	\$27.28
5/16	8.0	LS5-E080GLO-01	\$27.47
11/32	9.0	LS5-E090GLO-01	\$29.21
3/8	10.0	LS5-E100GLO-01	\$28.98
7/16	11.0	LS5-E110GLO-01	\$29.42
1/2	12.5	LS5-E125GLO-01	\$29.96
9/16	15.0	LS5-E150GLO-01	\$36.02
43/64	17.0	LS5-E175GLO-01	\$37.06
3/4	20.0	LS5-E200GLO-01	\$38.59
55/64	22.0	LS5-E225GLO-01	\$40.15
1	25.0	LS5-E250GLO-01	\$41.68
1-3/16	30.0	LS5-E300GLO-01	\$44.78

GLOSS



Height (in)	Height (mm)	Item Number	Price Each
Length: 8' 2-1/2" (2.5 m)			
3/16	4.5	LS5-E045BRU-01	\$32.11
1/4	6.0	LS5-E060BRU-01	\$32.73
5/16	8.0	LS5-E080BRU-01	\$33.97
3/8	10.0	LS5-E100BRU-01	\$35.81
7/16	11.0	LS5-E110BRU-01	\$37.02
1/2	12.5	LS5-E125BRU-01	\$37.05
9/16	15.0	LS5-E150BRU-01	\$44.54
3/4	20.0	LS5-E200BRU-01	\$47.72
1	25.0	LS5-E250BRU-01	\$51.53
1-3/16	30.0	LS5-E300BRU-01	\$55.37

BRUSHED



Height (in)	Height (mm)	Item Number	Price Each
Length: 8' 2-1/2" (2.5 m)			
5/16	8.0	LS6-E080CRP-01	\$39.07
3/8	10.0	LS6-E100CRP-01	\$41.18
7/16	11.0	LS6-E110CRP-01	\$42.57
1/2	12.5	LS6-E125CRP-01	\$42.61

CHROME PLATED



Height (in)	Height (mm)	Item Number	Price Each
Length: 8' 2-1/2" (2.5 m)			
5/16	8.0	LS6-E080GLG-01	\$39.07
3/8	10.0	LS6-E100GLG-01	\$41.18
1/2	12.5	LS6-E125GLG-01	\$42.61

GOLD GLOSS



Height (in)	Height (mm)	Item Number	Price Each
Length: 8' 2-1/2" (2.5 m)			
5/16	8.0	LS6-E080BLG-01	\$39.07
3/8	10.0	LS6-E100BLG-01	\$41.18
1/2	12.5	LS6-E125BLG-01	\$42.61

BLACK GLOSS



L-SHAPE EDGE PROFILES MADE OF ALUMINUM

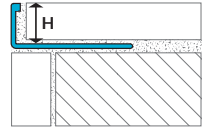

Height (in)	Height (mm)	Item Number	Price Each
<b>Length: 8' 2-1/2" (2.5 m)</b>			
3/32	2.0	LS1-A020NAT-01	\$8.18
1/8	3.0	LS1-A030NAT-01	\$8.58
3/16	4.5	LS1-A045NAT-01	\$8.78
1/4	6.0	LS1-A060NAT-01	\$9.38
5/16	8.0	LS1-A080NAT-01	\$9.42
11/32	9.0	LS1-A090NAT-01	\$10.03
3/8	10.0	LS1-A100NAT-01	\$9.91
7/16	11.0	LS1-A110NAT-01	\$10.24
1/2	12.5	LS1-A125NAT-01	\$10.42
9/16	15.0	LS1-A150NAT-01	\$12.89
5/8	16.0	LS1-A160NAT-01	\$13.26
11/16	17.5	LS1-A175NAT-01	\$14.08
3/4	20.0	LS1-A200NAT-01	\$14.66
7/8	22.5	LS1-A225NAT-01	\$15.61
1	25.0	LS1-A250NAT-01	\$16.39
1-3/16	30.0	LS1-A300NAT-01	\$18.17



L-SHAPE EDGE PROFILES MADE OF ANODIZED ALUMINUM

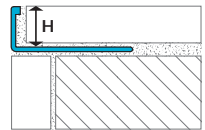

Height (in)	Height (mm)	Item Number	Price Each
<b>Length: 8' 2-1/2" (2.5 m)</b>			
3/32	2.0	LS2-A020SAT-01	\$12.51
1/8	3.0	LS2-A030SAT-01	\$13.10
3/16	4.5	LS2-A045SAT-01	\$13.42
1/4	6.0	LS2-A060SAT-01	\$14.00
5/16	8.0	LS2-A080SAT-01	\$13.91
11/32	9.0	LS2-A090SAT-01	\$15.08
3/8	10.0	LS2-A100SAT-01	\$14.75
7/16	11.0	LS2-A110SAT-01	\$15.71
1/2	12.5	LS2-A125SAT-01	\$15.81
9/16	15.0	LS2-A150SAT-01	\$17.83
5/8	16.0	LS2-A160SAT-01	\$19.33
11/16	17.5	LS2-A175SAT-01	\$20.46
3/4	20.0	LS2-A200SAT-01	\$22.18
7/8	22.5	LS2-A225SAT-01	\$23.33
1	25.0	LS2-A250SAT-01	\$24.45
1-3/16	30.0	LS2-A300SAT-01	\$27.28
<b>Length: 10' (3.0 m)</b>			
3/8	10.0	LS2-A100SAT-02	\$18.44
1/2	12.5	LS2-A125SAT-02	\$19.77



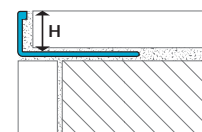

L-SHAPE EDGE PROFILES MADE OF ANODIZED ALUMINUM

Height (in)	Height (mm)	Item Number	Price Each
<b>Length: 8' 2-1/2" (2.5 m)</b>			
1/4	6.0	LS2-A060PCR-01	\$16.36
5/16	8.0	LS2-A080PCR-01	\$17.49
3/8	10.0	LS2-A100PCR-01	\$19.35
1/2	12.5	LS2-A125PCR-01	\$20.47
<b>Length: 10' (3.0 m)</b>			
5/16	8.0	LS2-A080PCR-02	\$21.86
3/8	10.0	LS2-A100PCR-02	\$24.17
1/2	12.5	LS2-A125PCR-02	\$25.57



Height (in)	Height (mm)	Item Number	Price Each
<b>Length: 8' 2-1/2" (2.5 m)</b>			
5/16	8.0	LS2-A080BCR-01	\$17.96
3/8	10.0	LS2-A100BCR-01	\$19.87
1/2	12.5	LS2-A125BCR-01	\$20.98



Height (in)	Height (mm)	Item Number	Price Each
<b>Length: 8' 2-1/2" (2.5 m)</b>			
1/4	6.0	LS2-A060SNI-01	\$16.64
5/16	8.0	LS2-A080SNI-01	\$16.99
3/8	10.0	LS2-A100SNI-01	\$17.32
1/2	12.5	LS2-A125SNI-01	\$17.89
<b>Length: 10' (3.0 m)</b>			
5/16	8.0	LS2-A080SNI-02	\$21.25
3/8	10.0	LS2-A100SNI-02	\$21.65
1/2	12.5	LS2-A125SNI-02	\$22.37

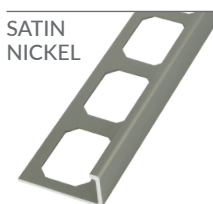

Height (in)	Height (mm)	Item Number	Price Each
<b>Length: 8' 2-1/2" (2.5 m)</b>			
1/4	6.0	LS2-A060BNI-01	\$19.33
5/16	8.0	LS2-A080BNI-01	\$19.56
3/8	10.0	LS2-A100BNI-01	\$19.97
1/2	12.5	LS2-A125BNI-01	\$20.84



Height (in)	Height (mm)	Item Number	Price Each
<b>Length: 8' 2-1/2" (2.5 m)</b>			
5/16	8.0	LS2-A080PNI-01	\$21.87
3/8	10.0	LS2-A100PNI-01	\$22.46
1/2	12.5	LS2-A125PNI-01	\$22.64



Height (in)	Height (mm)	Item Number	Price Each
<b>Length: 8' 2-1/2" (2.5 m)</b>			
5/16	8.0	LS2-A080SBR-01	\$14.51
3/8	10.0	LS2-A100SBR-01	\$16.18
1/2	12.5	LS2-A125SBR-01	\$17.29



Height (in)	Height (mm)	Item Number	Price Each
<b>Length: 8' 2-1/2" (2.5 m)</b>			
3/16	4.5	LS2-A045HGB-01	\$15.77
1/4	6.0	LS2-A060HGB-01	\$16.66
5/16	8.0	LS2-A080HGB-01	\$17.00
3/8	10.0	LS2-A100HGB-01	\$18.24
1/2	12.5	LS2-A125HGB-01	\$18.82



Height (in)	Height (mm)	Item Number	Price Each
<b>Length: 8' 2-1/2" (2.5 m)</b>			
5/16	8.0	LS2-A080BBL-01	\$18.68
3/8	10.0	LS2-A100BBL-01	\$19.61
1/2	12.5	LS2-A125BBL-01	\$20.23



L-SHAPE EDGE PROFILES MADE OF ANODIZED ALUMINUM

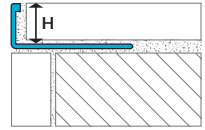

Height (in)	Height (mm)	Item Number	Price Each
Length: 8' 2-1/2" (2.5 m)			
5/16	8.0	LS2-A080ABB-01	\$21.73
3/8	10.0	LS2-A100ABB-01	\$22.38
1/2	12.5	LS2-A125ABB-01	\$24.25
Length: 10' (3.0 m)			
5/16	8.0	LS2-A080ABB-02	\$27.16
3/8	10.0	LS2-A100ABB-02	\$27.99
1/2	12.5	LS2-A125ABB-02	\$30.30



Height (in)	Height (mm)	Item Number	Price Each
Length: 8' 2-1/2" (2.5 m)			
5/16	8.0	LS2-A080BBR-01	\$19.24
3/8	10.0	LS2-A100BBR-01	\$20.65
1/2	12.5	LS2-A125BBR-01	\$21.74



Height (in)	Height (mm)	Item Number	Price Each
Length: 8' 2-1/2" (2.5 m)			
5/16	8.0	LS2-A080BGR-01	\$21.73
3/8	10.0	LS2-A100BGR-01	\$22.82
1/2	12.5	LS2-A125BGR-01	\$24.25



Height (in)	Height (mm)	Item Number	Price Each
Length: 8' 2-1/2" (2.5 m)			
5/16	8.0	LS2-A080BCU-01	\$19.94
3/8	10.0	LS2-A100BCU-01	\$20.36
1/2	12.5	LS2-A125BCU-01	\$20.84



L-SHAPE EDGE PROFILES MADE OF COLOR COATED ALUMINUM

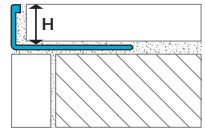

Height (in)	Height (mm)	Item Number	Price Each
Length: 8' 2-1/2" (2.5 m)			
1/4	6.0	LS3-A060BWH-01	\$16.66
5/16	8.0	LS3-A080BWH-01	\$17.00
3/8	10.0	LS3-A100BWH-01	\$18.24
1/2	12.5	LS3-A125BWH-01	\$18.82



Height (in)	Height (mm)	Item Number	Price Each
Length: 8' 2-1/2" (2.5 m)			
3/8	10.0	LS3-A100SPE-01	\$18.24
1/2	12.5	LS3-A125SPE-01	\$18.82



Height (in)	Height (mm)	Item Number	Price Each
Length: 8' 2-1/2" (2.5 m)			
1/4	6.0	LS3-A060MUS-01	\$16.66
5/16	8.0	LS3-A080MUS-01	\$17.00
3/8	10.0	LS3-A100MUS-01	\$18.24
1/2	12.5	LS3-A125MUS-01	\$18.82



Height (in)	Height (mm)	Item Number	Price Each
Length: 8' 2-1/2" (2.5 m)			
3/8	10.0	LS3-A100LBE-01	\$18.24
1/2	12.5	LS3-A125LBE-01	\$18.82



Height (in)	Height (mm)	Item Number	Price Each
Length: 8' 2-1/2" (2.5 m)			
1/4	6.0	LS3-A060FRO-01	\$16.66
5/16	8.0	LS3-A080FRO-01	\$17.00
3/8	10.0	LS3-A100FRO-01	\$18.24
1/2	12.5	LS3-A125FRO-01	\$18.82



Height (in)	Height (mm)	Item Number	Price Each
Length: 8' 2-1/2" (2.5 m)			
3/8	10.0	LS3-A100MHG-01	\$18.24
1/2	12.5	LS3-A125MHG-01	\$18.82





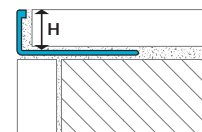

L-SHAPE EDGE PROFILES MADE OF COLOR COATED ALUMINUM

Height (in)	Height (mm)	Item Number	Price Each
Length: 8' 2-1/2" (2.5 m)			
3/8	10.0	LS3-A100GRE-01	\$18.24
1/2	12.5	LS3-A125GRE-01	\$18.82

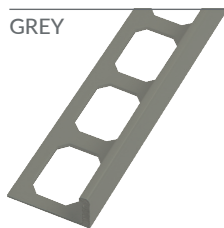

Height (in)	Height (mm)	Item Number	Price Each
Length: 8' 2-1/2" (2.5 m)			
3/8	10.0	LS3-A100BLB-01	\$18.24
1/2	12.5	LS3-A125BLB-01	\$18.82



Height (in)	Height (mm)	Item Number	Price Each
Length: 8' 2-1/2" (2.5 m)			
1/4	6.0	LS3-A060MBL-01	\$16.66
5/16	8.0	LS3-A080MBL-01	\$17.00
3/8	10.0	LS3-A100MBL-01	\$18.24
1/2	12.5	LS3-A125MBL-01	\$18.82

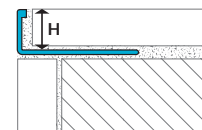

L-SHAPE EDGE PROFILES MADE OF TEXTURE COATED ALUMINUM

Height (in)	Height (mm)	Item Number	Price Each
Length: 8' 2-1/2" (2.5 m)			
5/16	8.0	LS4-A080MBW-01	\$24.08
3/8	10.0	LS4-A100MBW-01	\$24.54
1/2	12.5	LS4-A125MBW-01	\$25.30



Height (in)	Height (mm)	Item Number	Price Each
Length: 8' 2-1/2" (2.5 m)			
5/16	8.0	LS4-A080IVO-01	\$30.11
3/8	10.0	LS4-A100IVO-01	\$30.69
1/2	12.5	LS4-A125IVO-01	\$31.62



Height (in)	Height (mm)	Item Number	Price Each
Length: 8' 2-1/2" (2.5 m)			
5/16	8.0	LS4-A080GRG-01	\$30.11
3/8	10.0	LS4-A100GRG-01	\$30.69
1/2	12.5	LS4-A125GRG-01	\$31.62



Height (in)	Height (mm)	Item Number	Price Each
Length: 8' 2-1/2" (2.5 m)			
3/8	10.0	LS4-A100STG-01	\$30.69
1/2	12.5	LS4-A125STG-01	\$31.62



Height (in)	Height (mm)	Item Number	Price Each
Length: 8' 2-1/2" (2.5 m)			
1/4	6.0	LS4-A060ANW-01	\$29.45
5/16	8.0	LS4-A080ANW-01	\$30.11
3/8	10.0	LS4-A100ANW-01	\$30.69
1/2	12.5	LS4-A125ANW-01	\$31.62



Height (in)	Height (mm)	Item Number	Price Each
Length: 8' 2-1/2" (2.5 m)			
5/16	8.0	LS4-A080DKH-01	\$30.11
3/8	10.0	LS4-A100DKH-01	\$30.69
1/2	12.5	LS4-A125DKH-01	\$31.62



L-SHAPE EDGE PROFILES MADE OF TEXTURE COATED ALUMINUM

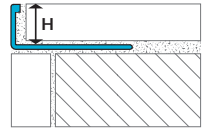

Height (in)	Height (mm)	Item Number	Price Each
Length: 8' 2-1/2" (2.5 m)			
5/16	8.0	LS4-A080CBR-01	\$30.11
3/8	10.0	LS4-A100CBR-01	\$30.69
1/2	12.5	LS4-A125CBR-01	\$31.62



Height (in)	Height (mm)	Item Number	Price Each
Length: 8' 2-1/2" (2.5 m)			
5/16	8.0	LS4-A080MOC-01	\$30.11
3/8	10.0	LS4-A100MOC-01	\$30.69
1/2	12.5	LS4-A125MOC-01	\$31.62



Height (in)	Height (mm)	Item Number	Price Each
Length: 8' 2-1/2" (2.5 m)			
5/16	8.0	LS4-A080DUG-01	\$30.11
3/8	10.0	LS4-A100DUG-01	\$30.69
1/2	12.5	LS4-A125DUG-01	\$31.62



Height (in)	Height (mm)	Item Number	Price Each
Length: 8' 2-1/2" (2.5 m)			
5/16	8.0	LS4-A080RAV-01	\$30.11
3/8	10.0	LS4-A100RAV-01	\$30.69
1/2	12.5	LS4-A120RAV-01	\$31.62



Height (in)	Height (mm)	Item Number	Price Each
Length: 8' 2-1/2" (2.5 m)			
1/4	6.0	LS4-A060MBL-01	\$23.56
5/16	8.0	LS4-A080MBL-01	\$24.08
3/8	10.0	LS4-A100MBL-01	\$24.54
1/2	12.5	LS4-A125MBL-01	\$25.30



L-SHAPE EDGE PROFILES MADE OF PVC

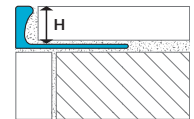

Height (in)	Height (mm)	Item Number	Price Each
Length: 8' 2-1/2" (2.5 m)			
5/16	8.0	LS8-P080BWH-01	\$5.75
3/8	10.0	LS8-P100BWH-01	\$5.88
1/2	12.5	LS8-P125BWH-01	\$6.20
Length: 10' (3.0 m)			
5/16	8.0	LS8-P080BWH-02	\$7.17
3/8	10.0	LS8-P100BWH-02	\$7.35
1/2	12.5	LS8-P125BWH-02	\$7.75



Height (in)	Height (mm)	Item Number	Price Each
Length: 8' 2-1/2" (2.5 m)			
5/16	8.0	LS8-P080ALM-01	\$5.75
3/8	10.0	LS8-P100ALM-01	\$5.88
1/2	12.5	LS8-P125ALM-01	\$6.20



Height (in)	Height (mm)	Item Number	Price Each
Length: 8' 2-1/2" (2.5 m)			
5/16	8.0	LS8-P080FRO-01	\$5.75
3/8	10.0	LS8-P100FRO-01	\$5.88
1/2	12.5	LS8-P125FRO-01	\$6.20



Height (in)	Height (mm)	Item Number	Price Each
Length: 8' 2-1/2" (2.5 m)			
5/16	8.0	LS8-P080BLK-01	\$5.75
3/8	10.0	LS8-P100BLK-01	\$5.88
1/2	12.5	LS8-P125BLK-01	\$6.20



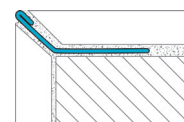

### FINISHING PROFILES MADE OF STAINLESS STEEL 304

inclined version 135°

Height (in)	Height (mm)	Item Number	Price Each
Length: 8' 2-1/2" (2.5 m)			
5/16	8.0	FP1-E090GLO-01	\$27.44
3/8	10.0	FP1-E110GLO-01	\$28.34
1/2	12.5	FP1-E125GLO-01	\$28.87

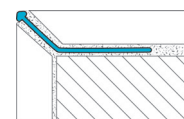

### FINISHING PROFILES MADE OF ANODIZED ALUMINUM

inclined version 135°

Height (in)	Height (mm)	Item Number	Price Each
Length: 8' 2-1/2" (2.5 m)			
1/2	12.5	FP1-A125SAT-01	\$17.82

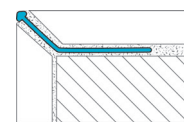
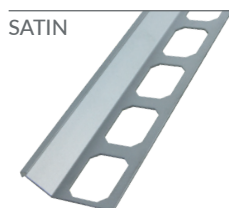

### FINISHING PROFILES MADE OF TEXTURE COATED ALUMINUM

inclined version 135°

Height (in)	Height (mm)	Item Number	Price Each
Length: 8' 2-1/2" (2.5 m)			
1/2	12.5	FP1-A125ANW-01	\$23.42



Height (in)	Height (mm)	Item Number	Price Each
Length: 8' 2-1/2" (2.5 m)			
1/2	12.5	FP1-A125DKH-01	\$23.42



Height (in)	Height (mm)	Item Number	Price Each
Length: 8' 2-1/2" (2.5 m)			
1/2	12.5	FP1-A125CBR-01	\$23.42



Height (in)	Height (mm)	Item Number	Price Each
Length: 8' 2-1/2" (2.5 m)			
1/2	12.5	FP1-A125MOC-01	\$23.42



Height (in)	Height (mm)	Item Number	Price Each
Length: 8' 2-1/2" (2.5 m)			
1/2	12.5	FP1-A125RAV-01	\$23.42



Height (in)	Height (mm)	Item Number	Price Each
Length: 8' 2-1/2" (2.5 m)			
1/2	12.5	FP1-A125DUG-01	\$23.42



**SQUARE EDGE PROFILES MADE OF STAINLESS STEEL 304**  
with corner pieces

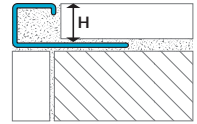

Height (in)	Height (mm)	Item Number	Price Each
<b>Length: 8' 2-1/2" (2.5 m)</b>			
9/32	7.0	SQ5-E070GLO-01	\$38.77
5/16	8.0	SQ5-E080GLO-01	\$39.01
11/32	9.0	SQ5-E090GLO-01	\$41.59
3/8	10.0	SQ5-E100GLO-01	\$41.90
7/16	11.0	SQ5-E110GLO-01	\$43.36
1/2	12.5	SQ5-E125GLO-01	\$44.63

Height (in)	Height (mm)	Item Number	Price Each
<b>Square Edge Corner Pieces*</b>			
9/32	7.0	SQ5-E070GLO-11	\$29.12
5/16	8.0	SQ5-E080GLO-11	\$29.51
11/32	9.0	SQ5-E090GLO-11	\$30.56
3/8	10.0	SQ5-E100GLO-11	\$31.88
7/16	11.0	SQ5-E110GLO-11	\$32.36
1/2	12.5	SQ5-E125GLO-11	\$32.72

GLOSS



Height (in)	Height (mm)	Item Number	Price Each
<b>Length: 8' 2-1/2" (2.5 m)</b>			
9/32	7.0	SQ5-E070BRU-01	\$57.05
5/16	8.0	SQ5-E080BRU-01	\$59.11
11/32	9.0	SQ5-E090BRU-01	\$61.20
3/8	10.0	SQ5-E100BRU-01	\$63.48
7/16	11.0	SQ5-E110BRU-01	\$65.70
1/2	12.5	SQ5-E125BRU-01	\$67.64

Height (in)	Height (mm)	Item Number	Price Each
<b>Square Edge Corner Pieces*</b>			
9/32	7.0	SQ5-E070BRU-11	\$35.03
5/16	8.0	SQ5-E080BRU-11	\$35.39
11/32	9.0	SQ5-E090BRU-11	\$36.63
3/8	10.0	SQ5-E100BRU-11	\$38.22
7/16	11.0	SQ5-E110BRU-11	\$38.79
1/2	12.5	SQ5-E125BRU-11	\$39.16

BRUSHED



\* All corner pieces can be used both as internal and external corners.

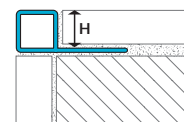

### SQUARE EDGE PROFILES MADE OF ANODIZED ALUMINUM

with corner pieces

Height (in)	Height (mm)	Item Number	Price Each
<b>Length: 8' 2-1/2" (2.5 m)</b>			
9/32	7.0	SQ2-A070SAT-01	\$17.25
5/16	8.0	SQ2-A080SAT-01	\$17.61
11/32	9.0	SQ2-A090SAT-01	\$18.33
3/8	10.0	SQ2-A100SAT-01	\$19.04
7/16	11.0	SQ2-A110SAT-01	\$20.05
1/2	12.5	SQ2-A125SAT-01	\$21.26

Height (in)	Height (mm)	Item Number	Price Each
<b>Length: 8' 2-1/2" (2.5 m)</b>			
9/32	7.0	SQ2-A070PCR-01	\$22.51
5/16	8.0	SQ2-A080PCR-01	\$23.91
11/32	9.0	SQ2-A090PCR-01	\$25.14
3/8	10.0	SQ2-A100PCR-01	\$26.37
7/16	11.0	SQ2-A110PCR-01	\$28.06
1/2	12.5	SQ2-A125PCR-01	\$30.89
<b>Length: 10' (3.0 m)</b>			
1/2	12.5	SQ2-A125PCR-02	\$38.62

Height (in)	Height (mm)	Item Number	Price Each
<b>Length: 8' 2-1/2" (2.5 m)</b>			
9/32	7.0	SQ2-A070BCR-01	\$30.84
11/32	9.0	SQ2-A090BCR-01	\$34.44
3/8	10.0	SQ2-A100BCR-01	\$36.13
7/16	11.0	SQ2-A110BCR-01	\$38.44
1/2	12.5	SQ2-A125BCR-01	\$42.32

Height (in)	Height (mm)	Item Number	Price Each
<b>Length: 8' 2-1/2" (2.5 m)</b>			
9/32	7.0	SQ2-A070SNI-01	\$18.41
11/32	9.0	SQ2-A090SNI-01	\$21.81
3/8	10.0	SQ2-A100SNI-01	\$20.25
7/16	11.0	SQ2-A110SNI-01	\$20.98
1/2	12.5	SQ2-A125SNI-01	\$22.55

Height (in)	Height (mm)	Item Number	Price Each
<b>Length: 8' 2-1/2" (2.5 m)</b>			
9/32	7.0	SQ2-A070BNI-01	\$22.13
5/16	8.0	SQ2-A080BNI-01	\$23.29
11/32	9.0	SQ2-A090BNI-01	\$24.61
3/8	10.0	SQ2-A100BNI-01	\$25.92
7/16	11.0	SQ2-A110BNI-01	\$26.42
1/2	12.5	SQ2-A125BNI-01	\$28.00

Height (in)	Height (mm)	Item Number	Price Each
<b>Square Edge Corner Pieces*</b>			
9/32	7.0	SQ2-A070SAT-11	\$7.68
5/16	8.0	SQ2-A080SAT-11	\$7.68
11/32	9.0	SQ2-A090SAT-11	\$7.68
3/8	10.0	SQ2-A100SAT-11	\$7.68
7/16	11.0	SQ2-A110SAT-11	\$7.68
1/2	12.5	SQ2-A125SAT-11	\$7.68

Height (in)	Height (mm)	Item Number	Price Each
<b>Square Edge Corner Pieces*</b>			
9/32	7.0	SQ2-A070PCR-11	\$9.11
5/16	8.0	SQ2-A080PCR-11	\$9.11
11/32	9.0	SQ2-A090PCR-11	\$9.11
3/8	10.0	SQ2-A100PCR-11	\$9.11
7/16	11.0	SQ2-A110PCR-11	\$9.11
1/2	12.5	SQ2-A125PCR-11	\$9.11

Height (in)	Height (mm)	Item Number	Price Each
<b>Square Edge Corner Pieces*</b>			
9/32	7.0	SQ2-A070BCR-11	\$12.83
11/32	9.0	SQ2-A090BCR-11	\$12.83
3/8	10.0	SQ2-A100BCR-11	\$12.83
7/16	11.0	SQ2-A110BCR-11	\$12.83
1/2	12.5	SQ2-A125BCR-11	\$12.83

Height (in)	Height (mm)	Item Number	Price Each
<b>Square Edge Corner Pieces*</b>			
9/32	7.0	SQ2-A070SNI-11	\$7.53
11/32	9.0	SQ2-A090SNI-11	\$7.53
3/8	10.0	SQ2-A100SNI-11	\$7.53
7/16	11.0	SQ2-A110SNI-11	\$7.53
1/2	12.5	SQ2-A125SNI-11	\$7.53

Height (in)	Height (mm)	Item Number	Price Each
<b>Square Edge Corner Pieces*</b>			
9/32	7.0	SQ2-A070BNI-11	\$13.93
5/16	8.0	SQ2-A080BNI-11	\$13.93
11/32	9.0	SQ2-A090BNI-11	\$13.93
3/8	10.0	SQ2-A100BNI-11	\$13.93
7/16	11.0	SQ2-A110BNI-11	\$13.93
1/2	12.5	SQ2-A125BNI-11	\$13.93

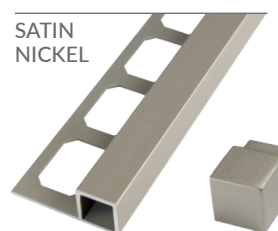
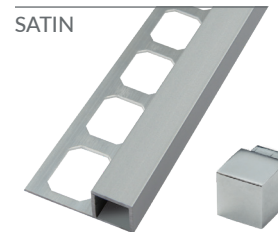

\* All corner pieces can be used both as internal and external corners.

SQUARE EDGE PROFILES MADE OF ANODIZED ALUMINUM

with corner pieces

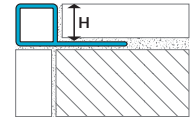

Height (in)	Height (mm)	Item Number	Price Each
Length: 8' 2-1/2" (2.5 m)			
9/32	7.0	SQ2-A070PNI-01	\$20.11
5/16	8.0	SQ2-A080PNI-01	\$21.17
11/32	9.0	SQ2-A090PNI-01	\$22.37
3/8	10.0	SQ2-A100PNI-01	\$23.56
7/16	11.0	SQ2-A110PNI-01	\$24.02
1/2	12.5	SQ2-A125PNI-01	\$25.45

Height (in)	Height (mm)	Item Number	Price Each
Square Edge Corner Pieces*			
9/32	7.0	SQ2-A070PNI-11	\$12.77
5/16	8.0	SQ2-A080PNI-11	\$12.77
11/32	9.0	SQ2-A090PNI-11	\$12.77
3/8	10.0	SQ2-A100PNI-11	\$12.77
7/16	11.0	SQ2-A110PNI-11	\$12.77
1/2	12.5	SQ2-A125PNI-11	\$12.77

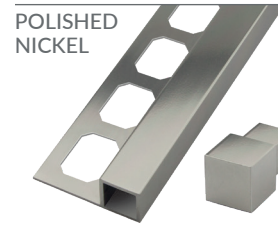

Height (in)	Height (mm)	Item Number	Price Each
Length: 8' 2-1/2" (2.5 m)			
3/8	10.0	SQ2-A100ABB-01	\$25.92
1/2	12.5	SQ2-A125ABB-01	\$28.00

Height (in)	Height (mm)	Item Number	Price Each
Square Edge Corner Pieces*			
3/8	10.0	SQ2-A100ABB-11	\$13.93
1/2	12.5	SQ2-A125ABB-11	\$13.93



Height (in)	Height (mm)	Item Number	Price Each
Length: 8' 2-1/2" (2.5 m)			
3/8	10.0	SQ2-A100BCU-01	\$25.92
1/2	12.5	SQ2-A125BCU-01	\$28.00

Height (in)	Height (mm)	Item Number	Price Each
Square Edge Corner Pieces*			
3/8	10.0	SQ2-A100BCU-11	\$13.93
1/2	12.5	SQ2-A125BCU-11	\$13.93



Height (in)	Height (mm)	Item Number	Price Each
Length: 8' 2-1/2" (2.5 m)			
3/8	10.0	SQ2-A100BBL-01	\$26.17

Height (in)	Height (mm)	Item Number	Price Each
Square Edge Corner Pieces*			
3/8	10.0	SQ2-A100BBL-11	\$13.93



SQUARE EDGE PROFILES MADE OF COLOR COATED ALUMINUM

with corner pieces

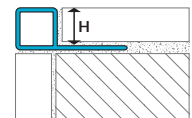

Height (in)	Height (mm)	Item Number	Price Each
Length: 8' 2-1/2" (2.5 m)			
3/8	10.0	SQ3-A100MBL-01	\$20.99
7/16	11.0	SQ3-A110MBL-01	\$21.64
1/2	12.5	SQ3-A125MBL-01	\$22.96

Height (in)	Height (mm)	Item Number	Price Each
Square Edge Corner Pieces*			
3/8	10.0	SQ3-A100MBL-11	\$4.19
7/16	11.0	SQ3-A110MBL-11	\$4.19
1/2	12.5	SQ3-A125MBL-11	\$4.19



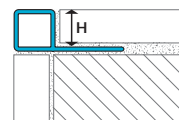

### SQUARE EDGE PROFILES MADE OF TEXTURE COATED ALUMINUM

with corner pieces

Height (in)	Height (mm)	Item Number	Price Each
<b>Length: 8' 2-1/2" (2.5 m)</b>			
3/8	10.0	SQ4-A100MBW-01	\$30.85
1/2	12.5	SQ4-A125MBW-01	\$31.51
<b>Length: 10' (3.0 m)</b>			
3/8	10.0	SQ4-A100MBW-02	\$38.57

Height (in)	Height (mm)	Item Number	Price Each
<b>Square Edge Corner Pieces*</b>			
3/8	10.0	SQ4-A100MBW-11	\$14.48
1/2	12.5	SQ4-A125MBW-11	\$14.48



MATTE BRILLANT WHITE

Height (in)	Height (mm)	Item Number	Price Each
<b>Length: 8' 2-1/2" (2.5 m)</b>			
3/8	10.0	SQ4-A100BRW-01	\$38.72
7/16	11.0	SQ4-A110BRW-01	\$39.26
1/2	12.5	SQ4-A125BRW-01	\$39.64
<b>Length: 10' (3.0 m)</b>			
3/8	10.0	SQ4-A100BRW-02	\$48.40
7/16	11.0	SQ4-A110BRW-02	\$49.07
1/2	12.5	SQ4-A125BRW-02	\$49.55

Height (in)	Height (mm)	Item Number	Price Each
<b>Square Edge Corner Pieces*</b>			
3/8	10.0	SQ4-A100BRW-11	\$14.48
7/16	11.0	SQ4-A110BRW-11	\$14.48
1/2	12.5	SQ4-A125BRW-11	\$14.48



BRIGHT WHITE



Height (in)	Height (mm)	Item Number	Price Each
<b>Length: 8' 2-1/2" (2.5 m)</b>			
3/8	10.0	SQ4-A100GRG-01	\$38.72
1/2	12.5	SQ4-A125GRG-01	\$39.64
<b>Length: 10' (3.0 m)</b>			
3/8	10.0	SQ4-A100GRG-02	\$48.40
1/2	12.5	SQ4-A125GRG-02	\$49.55

Height (in)	Height (mm)	Item Number	Price Each
<b>Square Edge Corner Pieces*</b>			
3/8	10.0	SQ4-A100GRG-11	\$14.48
1/2	12.5	SQ4-A125GRG-11	\$14.48

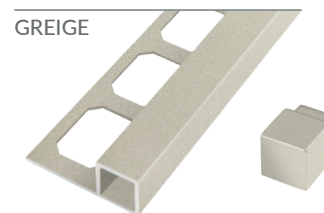

GREIGE

Height (in)	Height (mm)	Item Number	Price Each
<b>Length: 8' 2-1/2" (2.5 m)</b>			
3/8	10.0	SQ4-A100STG-01	\$38.72
1/2	12.5	SQ4-A125STG-01	\$39.64
<b>Length: 10' (3.0 m)</b>			
3/8	10.0	SQ4-A100STG-02	\$48.40
1/2	12.5	SQ4-A125STG-02	\$49.55

Height (in)	Height (mm)	Item Number	Price Each
<b>Square Edge Corner Pieces*</b>			
3/8	10.0	SQ4-A100STG-11	\$14.48
1/2	12.5	SQ4-A125STG-11	\$14.48

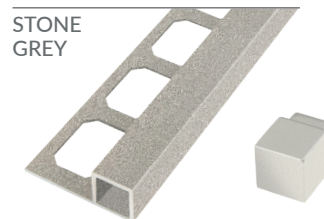

STONE GREY

\* All corner pieces can be used both as internal and external corners.

**SQUARE EDGE PROFILES MADE OF TEXTURE COATED ALUMINUM**  
with corner pieces

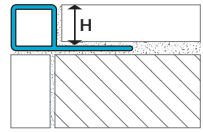

Height (in)	Height (mm)	Item Number	Price Each
<b>Length: 8' 2-1/2" (2.5 m)</b>			
3/8	10.0	SQ4-A100SMG-01	\$38.72
1/2	12.5	SQ4-A125SMG-01	\$39.64

Height (in)	Height (mm)	Item Number	Price Each
<b>Square Edge Corner Pieces*</b>			
3/8	10.0	SQ4-A100SMG-11	\$14.48
1/2	12.5	SQ4-A125SMG-11	\$14.48

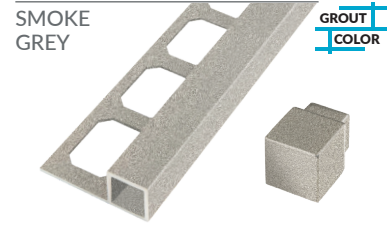

Height (in)	Height (mm)	Item Number	Price Each
<b>Length: 8' 2-1/2" (2.5 m)</b>			
3/8	10.0	SQ4-A100ANW-01	\$38.72
7/16	11.0	SQ4-A110ANW-01	\$39.26
1/2	12.5	SQ4-A125ANW-01	\$39.64
<b>Length: 10' (3.0 m)</b>			
3/8	10.0	SQ4-A100ANW-02	\$48.40
7/16	11.0	SQ4-A110ANW-02	\$49.07
1/2	12.5	SQ4-A125ANW-02	\$49.55

Height (in)	Height (mm)	Item Number	Price Each
<b>Square Edge Corner Pieces*</b>			
3/8	10.0	SQ4-A100ANW-11	\$14.48
7/16	11.0	SQ4-A110ANW-11	\$14.48
1/2	12.5	SQ4-A125ANW-11	\$14.48

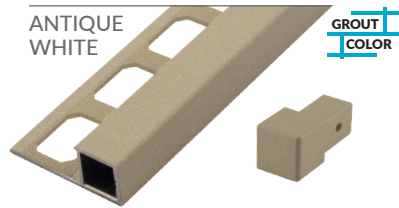

Height (in)	Height (mm)	Item Number	Price Each
<b>Length: 8' 2-1/2" (2.5 m)</b>			
3/8	10.0	SQ4-A100DKH-01	\$38.72
7/16	11.0	SQ4-A110DKH-01	\$39.26
1/2	12.5	SQ4-A125DKH-01	\$39.64
<b>Length: 10' (3.0 m)</b>			
3/8	10.0	SQ4-A100DKH-02	\$48.40
7/16	11.0	SQ4-A110DKH-02	\$49.07
1/2	12.5	SQ4-A125DKH-02	\$49.55

Height (in)	Height (mm)	Item Number	Price Each
<b>Square Edge Corner Pieces*</b>			
3/8	10.0	SQ4-A100DKH-11	\$14.48
7/16	11.0	SQ4-A110DKH-11	\$14.48
1/2	12.5	SQ4-A125DKH-11	\$14.48

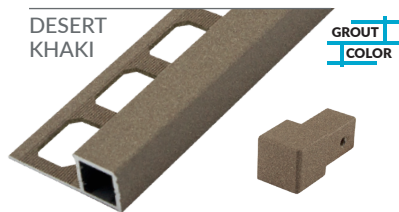

Height (in)	Height (mm)	Item Number	Price Each
<b>Length: 8' 2-1/2" (2.5 m)</b>			
3/8	10.0	SQ4-A100CBR-01	\$38.72
7/16	11.0	SQ4-A110CBR-01	\$39.26
1/2	12.5	SQ4-A125CBR-01	\$39.64
<b>Length: 10' (3.0 m)</b>			
3/8	10.0	SQ4-A100CBR-02	\$48.40
1/2	12.5	SQ4-A125CBR-02	\$49.55

Height (in)	Height (mm)	Item Number	Price Each
<b>Square Edge Corner Pieces*</b>			
3/8	10.0	SQ4-A100CBR-11	\$14.48
7/16	11.0	SQ4-A110CBR-11	\$14.48
1/2	12.5	SQ4-A125CBR-11	\$14.48



\* All corner pieces can be used both as internal and external corners.



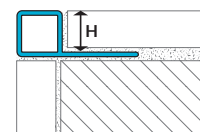

### SQUARE EDGE PROFILES MADE OF TEXTURE COATED ALUMINUM

with corner pieces

Height (in)	Height (mm)	Item Number	Price Each
<b>Length: 8' 2-1/2" (2.5 m)</b>			
3/8	10.0	SQ4-A100MOC-01	\$38.72
7/16	11.0	SQ4-A110MOC-01	\$39.26
1/2	12.5	SQ4-A125MOC-01	\$39.64
<b>Length: 10' (3.0 m)</b>			
3/8	10.0	SQ4-A100MOC-02	\$48.40
7/16	11.0	SQ4-A110MOC-02	\$49.07

Height (in)	Height (mm)	Item Number	Price Each
<b>Square Edge Corner Pieces*</b>			
3/8	10.0	SQ4-A100MOC-11	\$14.48
7/16	11.0	SQ4-A110MOC-11	\$14.48
1/2	12.5	SQ4-A125MOC-11	\$14.48

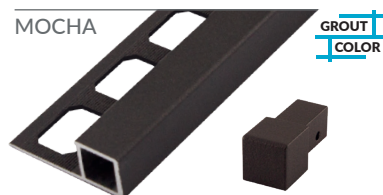

Height (in)	Height (mm)	Item Number	Price Each
<b>Length: 8' 2-1/2" (2.5 m)</b>			
3/8	10.0	SQ4-A100DUG-01	\$38.72
7/16	11.0	SQ4-A110DUG-01	\$39.26
1/2	12.5	SQ4-A125DUG-01	\$39.64
<b>Length: 10' (3.0 m)</b>			
3/8	10.0	SQ4-A100DUG-02	\$48.40
7/16	11.0	SQ4-A110DUG-02	\$49.07
1/2	12.5	SQ4-A125DUG-02	\$49.55

Height (in)	Height (mm)	Item Number	Price Each
<b>Square Edge Corner Pieces*</b>			
3/8	10.0	SQ4-A100DUG-11	\$14.48
7/16	11.0	SQ4-A110DUG-11	\$14.48
1/2	12.5	SQ4-A125DUG-11	\$14.48

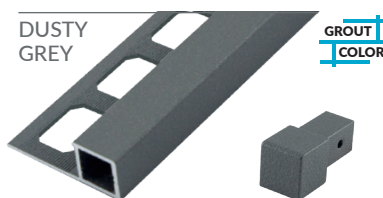

Height (in)	Height (mm)	Item Number	Price Each
<b>Length: 8' 2-1/2" (2.5 m)</b>			
3/8	10.0	SQ4-A100RAV-01	\$38.72
7/16	11.0	SQ4-A110RAV-01	\$39.26
1/2	12.5	SQ4-A125RAV-01	\$39.64
<b>Length: 10' (3.0 m)</b>			
3/8	10.0	SQ4-A100RAV-02	\$48.40
1/2	12.5	SQ4-A125RAV-02	\$49.55

Height (in)	Height (mm)	Item Number	Price Each
<b>Square Edge Corner Pieces*</b>			
3/8	10.0	SQ4-A100RAV-11	\$14.48
7/16	11.0	SQ4-A110RAV-11	\$14.48
1/2	12.5	SQ4-A125RAV-11	\$14.48



Height (in)	Height (mm)	Item Number	Price Each
<b>Length: 8' 2-1/2" (2.5 m)</b>			
5/16	8.0	SQ4-A080MBL-01	\$29.88
3/8	10.0	SQ4-A100MBL-01	\$30.85
7/16	11.0	SQ4-A110MBL-01	\$31.20
1/2	12.5	SQ4-A125MBL-01	\$31.51
<b>Length: 10' (3.0 m)</b>			
5/16	8.0	SQ4-A080MBL-02	\$37.36
3/8	10.0	SQ4-A100MBL-02	\$38.57
1/2	12.5	SQ4-A125MBL-02	\$39.38

Height (in)	Height (mm)	Item Number	Price Each
<b>Square Edge Corner Pieces*</b>			
5/16	8.0	SQ4-A080MBL-11	\$14.48
3/8	10.0	SQ4-A100MBL-11	\$14.48
7/16	11.0	SQ4-A110MBL-11	\$14.48
1/2	12.5	SQ4-A125MBL-11	\$14.48

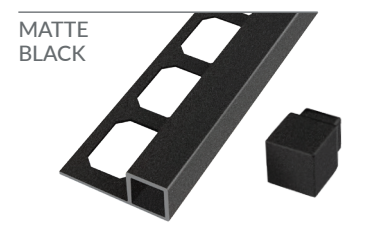

\* All corner pieces can be used both as internal and external corners.

**ROUND EDGE PROFILES MADE OF STAINLESS STEEL 304**  
with corner pieces

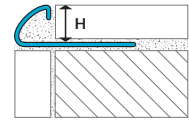

Height (in)	Height (mm)	Item Number	Price Each
<b>Length: 8' 2-1/2" (2.5 m)</b>			
1/4	6.0	R05-E060GLO-01	\$35.32
5/16	8.0	R05-E080GLO-01	\$36.88
3/8	10.0	R05-E100GLO-01	\$39.60
7/16	11.0	R05-E110GLO-01	\$40.89
1/2	12.5	R05-E125GLO-01	\$42.18

Height (in)	Height (mm)	Item Number	Price Each
<b>Outside Corners</b>			
1/4	6.0	R05-E060GLO-04	\$25.08
5/16	8.0	R05-E080GLO-04	\$26.94
3/8	10.0	R05-E100GLO-04	\$28.94
7/16	11.0	R05-E110GLO-04	\$29.95
1/2	12.5	R05-E125GLO-04	\$29.95

Height (in)	Height (mm)	Item Number	Price Each
<b>Inside Corners</b>			
1/4	6.0	R05-E060GLO-08	\$25.08
5/16	8.0	R05-E080GLO-08	\$26.94
3/8	10.0	R05-E100GLO-08	\$28.94
7/16	11.0	R05-E110GLO-08	\$29.95
1/2	12.5	R05-E125GLO-08	\$29.95

GLOSS



Height (in)	Height (mm)	Item Number	Price Each
<b>Length: 8' 2-1/2" (2.5 m)</b>			
1/4	6.0	R05-E060BRU-01	\$54.17
5/16	8.0	R05-E080BRU-01	\$56.54
3/8	10.0	R05-E100BRU-01	\$59.06
7/16	11.0	R05-E110BRU-01	\$60.23
1/2	12.5	R05-E125BRU-01	\$61.64

Height (in)	Height (mm)	Item Number	Price Each
<b>Outside Corners</b>			
1/4	6.0	R05-E060BRU-04	\$30.44
5/16	8.0	R05-E080BRU-04	\$30.44
3/8	10.0	R05-E100BRU-04	\$35.12
7/16	11.0	R05-E110BRU-04	\$35.12
1/2	12.5	R05-E125BRU-04	\$35.12

Height (in)	Height (mm)	Item Number	Price Each
<b>Inside Corners</b>			
1/4	6.0	R05-E060BRU-08	\$30.44
5/16	8.0	R05-E080BRU-08	\$30.44
3/8	10.0	R05-E100BRU-08	\$30.44
7/16	11.0	R05-E110BRU-08	\$30.44
1/2	12.5	R05-E125BRU-08	\$30.44

BRUSHED



**ROUND EDGE PROFILES MADE OF ANODIZED ALUMINUM**

with corner pieces

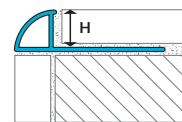

Height (in)	Height (mm)	Item Number	Price Each
<b>Length: 8' 2-1/2" (2.5 m)</b>			
1/4	6.0	R02-A060SAT-01	\$16.12
5/16	8.0	R02-A080SAT-01	\$16.82
3/8	10.0	R02-A100SAT-01	\$18.17
7/16	11.0	R02-A110SAT-01	\$18.85
1/2	12.5	R02-A125SAT-01	\$20.30
<b>Length: 10' (3.0 m)</b>			
3/8	10.0	R02-A100SAT-02	\$22.72
1/2	12.5	R02-A125SAT-02	\$25.35

Height (in)	Height (mm)	Item Number	Price Each
<b>Outside Corners</b>			
1/4	6.0	R02-A060SAT-04	\$7.12
5/16	8.0	R02-A080SAT-04	\$7.12
3/8	10.0	R02-A100SAT-04	\$7.12
7/16	11.0	R02-A110SAT-04	\$7.12
1/2	12.5	R02-A125SAT-04	\$7.12

Height (in)	Height (mm)	Item Number	Price Each
<b>Inside Corners</b>			
1/4	6.0	R02-A060SAT-08	\$7.12
5/16	8.0	R02-A080SAT-08	\$7.12
3/8	10.0	R02-A100SAT-08	\$7.12
7/16	11.0	R02-A110SAT-08	\$7.12
1/2	12.5	R02-A125SAT-08	\$7.12

SATIN

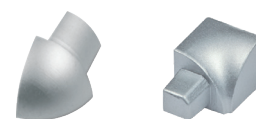

Height (in)	Height (mm)	Item Number	Price Each
<b>Length: 8' 2-1/2" (2.5 m)</b>			
1/4	6.0	R02-A060PCR-01	\$19.71
5/16	8.0	R02-A080PCR-01	\$22.10
3/8	10.0	R02-A100PCR-01	\$24.47
1/2	12.5	R02-A125PCR-01	\$28.64
<b>Length: 10' (3.0 m)</b>			
5/16	8.0	R02-A080PCR-02	\$27.62
3/8	10.0	R02-A100PCR-02	\$30.59
1/2	12.5	R02-A125PCR-02	\$35.80

Height (in)	Height (mm)	Item Number	Price Each
<b>Outside Corners</b>			
1/4	6.0	R02-A060PCR-04	\$8.44
5/16	8.0	R02-A080PCR-04	\$8.44
3/8	10.0	R02-A100PCR-04	\$8.44
1/2	12.5	R02-A125PCR-04	\$8.44

Height (in)	Height (mm)	Item Number	Price Each
<b>Inside Corners</b>			
1/4	6.0	R02-A060PCR-08	\$8.44
5/16	8.0	R02-A080PCR-08	\$8.44
3/8	10.0	R02-A100PCR-08	\$8.44
1/2	12.5	R02-A125PCR-08	\$8.44

POLISHED CHROME



ROUND EDGE PROFILES MADE OF ANODIZED ALUMINUM

with corner pieces

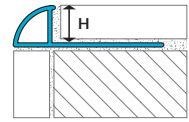

Height (in)	Height (mm)	Item Number	Price Each
<b>Length: 8' 2-1/2" (2.5 m)</b>			
5/16	8.0	RO2-A080BCR-01	\$22.68
3/8	10.0	RO2-A100BCR-01	\$25.66
1/2	12.5	RO2-A125BCR-01	\$29.84

Height (in)	Height (mm)	Item Number	Price Each
<b>Outside Corners</b>			
5/16	8.0	RO2-A080BCR-04	\$13.29
3/8	10.0	RO2-A100BCR-04	\$13.29
1/2	12.5	RO2-A125BCR-04	\$13.29

Height (in)	Height (mm)	Item Number	Price Each
<b>Inside Corners</b>			
5/16	8.0	RO2-A080BCR-08	\$13.29
3/8	10.0	RO2-A100BCR-08	\$13.29
1/2	12.5	RO2-A125BCR-08	\$13.29

BRUSHED CHROME



Height (in)	Height (mm)	Item Number	Price Each
<b>Length: 8' 2-1/2" (2.5 m)</b>			
5/16	8.0	RO2-A080SNI-01	\$17.62
3/8	10.0	RO2-A100SNI-01	\$18.41
1/2	12.5	RO2-A125SNI-01	\$20.89
<b>Length: 10' (3.0 m)</b>			
5/16	8.0	RO2-A080SNI-02	\$22.01
3/8	10.0	RO2-A100SNI-02	\$23.02
1/2	12.5	RO2-A125SNI-02	\$26.12

Height (in)	Height (mm)	Item Number	Price Each
<b>Outside Corners</b>			
5/16	8.0	RO2-A080SNI-04	\$7.18
3/8	10.0	RO2-A100SNI-04	\$7.18
1/2	12.5	RO2-A125SNI-04	\$7.18

Height (in)	Height (mm)	Item Number	Price Each
<b>Inside Corners</b>			
5/16	8.0	RO2-A080SNI-08	\$7.18
3/8	10.0	RO2-A100SNI-08	\$7.18
1/2	12.5	RO2-A125SNI-08	\$7.18

SATIN NICKEL

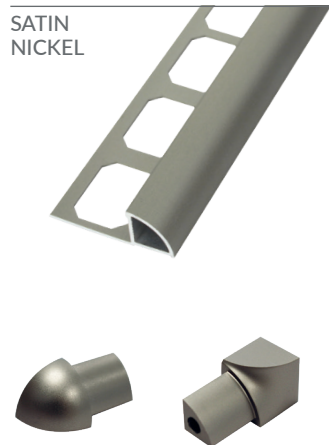

Height (in)	Height (mm)	Item Number	Price Each
<b>Length: 8' 2-1/2" (2.5 m)</b>			
5/16	8.0	RO2-A080PNI-01	\$22.68
3/8	10.0	RO2-A100PNI-01	\$26.87
1/2	12.5	RO2-A125PNI-01	\$30.44

Height (in)	Height (mm)	Item Number	Price Each
<b>Outside Corners</b>			
5/16	8.0	RO2-A080PNI-04	\$8.44
3/8	10.0	RO2-A100PNI-04	\$8.44
1/2	12.5	RO2-A125PNI-04	\$8.44

Height (in)	Height (mm)	Item Number	Price Each
<b>Inside Corners</b>			
5/16	8.0	RO2-A080PNI-08	\$8.44
3/8	10.0	RO2-A100PNI-08	\$8.44
1/2	12.5	RO2-A125PNI-08	\$8.44

POLISHED NICKEL

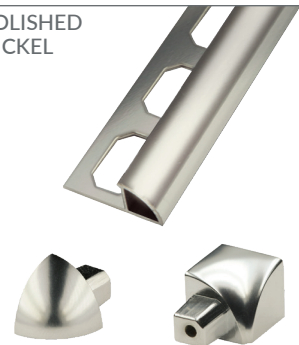

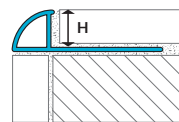

**ROUND EDGE PROFILES MADE OF ANODIZED ALUMINUM**

with corner pieces

Height (in)	Height (mm)	Item Number	Price Each
<b>Length: 8' 2-1/2" (2.5 m)</b>			
5/16	8.0	R02-A080BNI-01	\$25.07
3/8	10.0	R02-A100BNI-01	\$27.53
1/2	12.5	R02-A125BNI-01	\$31.92

Height (in)	Height (mm)	Item Number	Price Each
<b>Outside Corners</b>			
5/16	8.0	R02-A080BNI-04	\$13.15
3/8	10.0	R02-A100BNI-04	\$13.15
1/2	12.5	R02-A125BNI-04	\$13.15

Height (in)	Height (mm)	Item Number	Price Each
<b>Inside Corners</b>			
5/16	8.0	R02-A080BNI-08	\$13.15
3/8	10.0	R02-A100BNI-08	\$13.15
1/2	12.5	R02-A125BNI-08	\$13.15

BRUSHED NICKEL



Height (in)	Height (mm)	Item Number	Price Each
<b>Length: 8' 2-1/2" (2.5 m)</b>			
5/16	8.0	R02-A080SBR-01	\$19.71
3/8	10.0	R02-A100SBR-01	\$22.10
1/2	12.5	R02-A125SBR-01	\$25.66

Height (in)	Height (mm)	Item Number	Price Each
<b>Outside Corners</b>			
5/16	8.0	R02-A080-SBR-01	\$7.18
3/8	10.0	R02-A100SBR-04	\$7.18
1/2	12.5	R02-A125SBR-04	\$7.18

Height (in)	Height (mm)	Item Number	Price Each
<b>Inside Corners</b>			
5/16	8.0	R02-A080SBR-08	\$7.18
3/8	10.0	R02-A100SBR-08	\$7.18
1/2	12.5	R02-A125SBR-08	\$7.18

SATIN BRASS

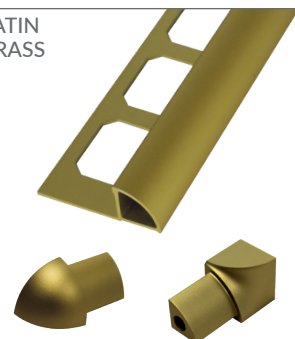

Height (in)	Height (mm)	Item Number	Price Each
<b>Length: 8' 2-1/2" (2.5 m)</b>			
3/8	10.0	R02-A100BBR-01	\$26.87
1/2	12.5	R02-A125BBR-01	\$30.44

Height (in)	Height (mm)	Item Number	Price Each
<b>Outside Corners</b>			
8-Mar	10.0	R02-A100BBR-04	\$13.54
1/2	12.5	R02-A125BBR-04	\$13.54

Height (in)	Height (mm)	Item Number	Price Each
<b>Inside Corners</b>			
3/8	10.0	R02-A100BBR-08	\$13.54
1/2	12.5	R02-A125BBR-08	\$13.54

BRUSHED BRASS

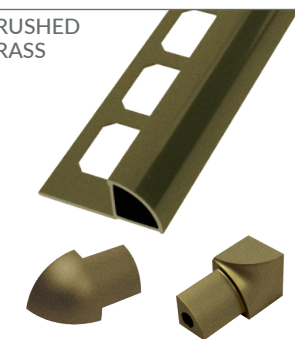

ROUND EDGE PROFILES MADE OF ANODIZED ALUMINUM

with corner pieces

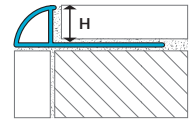

Height (in)	Height (mm)	Item Number	Price Each
Length: 8' 2-1/2" (2.5 m)			
3/8	10.0	R02-A100HGB-01	\$27.39
1/2	12.5	R02-A125HGB-01	\$31.05

Height (in)	Height (mm)	Item Number	Price Each
Outside Corners			
3/8	10.0	R02-A100HGB-04	\$8.87
1/2	12.5	R02-A125HGB-04	\$8.87

Height (in)	Height (mm)	Item Number	Price Each
Inside Corners			
3/8	10.0	R02-A100HGB-08	\$8.87
1/2	12.5	R02-A125HGB-08	\$8.87

HIGH GLOSS BLACK



Height (in)	Height (mm)	Item Number	Price Each
Length: 8' 2-1/2" (2.5 m)			
3/8	10.0	R02-A100BBL-01	\$28.05
1/2	12.5	R02-A125BBL-01	\$31.02

Height (in)	Height (mm)	Item Number	Price Each
Outside Corners			
3/8	10.0	R02-A100BBL-04	\$13.41
1/2	12.5	R02-A125BBL-04	\$13.41

Height (in)	Height (mm)	Item Number	Price Each
Inside Corners			
3/8	10.0	R02-A100BBL-08	\$13.41
1/2	12.5	R02-A125BBL-08	\$13.41

BRUSHED HIGH GLOSS BLACK



Height (in)	Height (mm)	Item Number	Price Each
Length: 8' 2-1/2" (2.5 m)			
3/8	10.0	R02-A100ABB-01	\$28.05
1/2	12.5	R02-A125ABB-01	\$31.92

Height (in)	Height (mm)	Item Number	Price Each
Outside Corners			
3/8	10.0	R02-A100ABB-04	\$13.29
1/2	12.5	R02-A125ABB-04	\$13.29

Height (in)	Height (mm)	Item Number	Price Each
Inside Corners			
3/8	10.0	R02-A100ABB-08	\$13.29
1/2	12.5	R02-A125ABB-08	\$13.29

ANTIQUÉ BRUSHED BRONZE



Height (in)	Height (mm)	Item Number	Price Each
Length: 8' 2-1/2" (2.5 m)			
3/8	10.0	R02-A100BCU-01	\$28.05
1/2	12.5	R02-A125BCU-01	\$31.92

Height (in)	Height (mm)	Item Number	Price Each
Outside Corners			
3/8	10.0	R02-A100BCU-04	\$13.29
1/2	12.5	R02-A125BCU-04	\$13.29

Height (in)	Height (mm)	Item Number	Price Each
Inside Corners			
3/8	10.0	R02-A100BCU-08	\$13.29
1/2	12.5	R02-A125BCU-08	\$13.29

BRUSHED COPPER



ROUND EDGE PROFILES MADE OF COLOR COATED ALUMINUM

with corner pieces

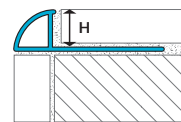

Height (in)	Height (mm)	Item Number	Price Each
<b>Length: 8' 2-1/2" (2.5 m)</b>			
1/4	6.0	R03-A060BWH-01	\$18.96
5/16	8.0	R03-A080BWH-01	\$21.25
3/8	10.0	R03-A100BWH-01	\$23.30
1/2	12.5	R03-A125BWH-01	\$29.12

Height (in)	Height (mm)	Item Number	Price Each
<b>Outside Corners</b>			
1/4	6.0	R03-A060BWH-04	\$4.28
5/16	8.0	R03-A080BWH-04	\$4.28
3/8	10.0	R03-A100BWH-04	\$4.28
1/2	12.5	R03-A125BWH-04	\$4.28

Height (in)	Height (mm)	Item Number	Price Each
<b>Inside Corners</b>			
1/4	6.0	R03-A060BWH-08	\$4.28
5/16	8.0	R03-A080BWH-08	\$4.28
3/8	10.0	R03-A100BWH-08	\$4.28
1/2	12.5	R03-A125BWH-08	\$4.28

BRILLIANT WHITE



Height (in)	Height (mm)	Item Number	Price Each
<b>Length: 8' 2-1/2" (2.5 m)</b>			
1/4	6.0	R03-A060FRO-01	\$18.96
5/16	8.0	R03-A080FRO-01	\$21.25
3/8	10.0	R03-A100FRO-01	\$23.30
1/2	12.5	R03-A125FRO-01	\$29.12

Height (in)	Height (mm)	Item Number	Price Each
<b>Outside Corners</b>			
1/4	6.0	R03-A060FRO-04	\$4.28
5/16	8.0	R03-A080FRO-04	\$4.28
3/8	10.0	R03-A100FRO-04	\$4.28
1/2	12.5	R03-A125FRO-04	\$4.28

Height (in)	Height (mm)	Item Number	Price Each
<b>Inside Corners</b>			
1/4	6.0	R03-A060FRO-08	\$4.28
5/16	8.0	R03-A080FRO-08	\$4.28
3/8	10.0	R03-A100FRO-08	\$4.28
1/2	12.5	R03-A125FRO-08	\$4.28

FROSTY

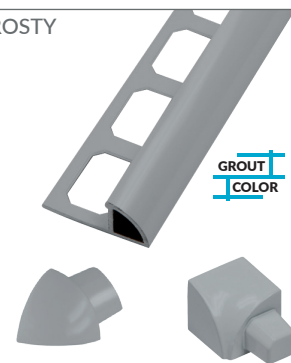

Height (in)	Height (mm)	Item Number	Price Each
<b>Length: 8' 2-1/2" (2.5 m)</b>			
3/8	10.0	R03-A100MHG-01	\$23.30
1/2	12.5	R03-A125MHG-01	\$29.12

Height (in)	Height (mm)	Item Number	Price Each
<b>Outside Corners</b>			
3/8	10.0	R03-A100MHG-04	\$4.28
1/2	12.5	R03-A125MHG-04	\$4.28

Height (in)	Height (mm)	Item Number	Price Each
<b>Inside Corners</b>			
3/8	10.0	R03-A100MHG-08	\$4.28
1/2	12.5	R03-A125MHG-08	\$4.28

MANHATTEN GREY

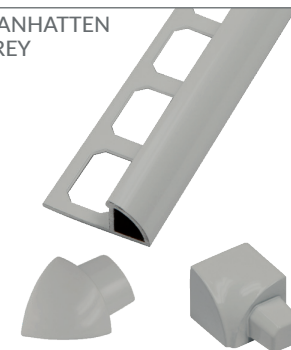

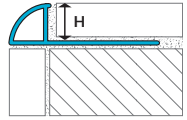

**ROUND EDGE PROFILES MADE OF PVC**  
with corner pieces

Height (in)	Height (mm)	Item Number	Price Each
<b>Length: 8' 2-1/2" (2.5 m)</b>			
5/16	8.0	R08-P080SPE-01	\$6.93
3/8	10.0	R08-P100SPE-01	\$7.38
1/2	12.5	R08-P125SPE-01	\$9.23

SAND  
PEBBLE



Height (in)	Height (mm)	Item Number	Price Each
<b>Length: 8' 2-1/2" (2.5 m)</b>			
5/16	8.0	R08-P080FRO-01	\$6.93
3/8	10.0	R08-P100FRO-01	\$7.38
1/2	12.5	R08-P125FRO-01	\$9.23

FROSTY

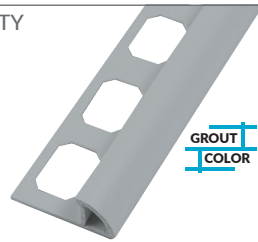



ROUND EDGE PROFILES MADE OF TEXTURE COATED ALUMINUM

with corner pieces

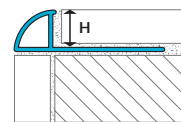

Height (in)	Height (mm)	Item Number	Price Each
<b>Length: 8' 2-1/2" (2.5 m)</b>			
3/8	10.0	RO4-A100MBW-01	\$31.45
1/2	12.5	RO4-A125MBW-01	\$32.11
<b>Length: 10' (3.0 m)</b>			
3/8	10.0	RO4-A100MBW-02	\$39.30
<b>Outside Corners</b>			
3/8	10.0	RO4-A100MBW-04	\$10.32
1/2	12.5	RO4-A125MBW-04	\$10.32

Height (in)	Height (mm)	Item Number	Price Each
<b>Inside Corners</b>			
3/8	10.0	RO4-A100MBW-08	\$10.32
1/2	12.5	RO4-A125MBW-08	\$10.32



Height (in)	Height (mm)	Item Number	Price Each
<b>Length: 8' 2-1/2" (2.5 m)</b>			
3/8	10.0	RO4-A100GRG-01	\$39.30
1/2	12.5	RO4-A125GRG-01	\$40.14
<b>Length: 10' (3.0 m)</b>			
3/8	10.0	RO4-A100GRG-02	\$49.14
<b>Outside Corners</b>			
3/8	10.0	RO4-A100GRG-04	\$13.30
1/2	12.5	RO4-A125GRG-04	\$13.30

Height (in)	Height (mm)	Item Number	Price Each
<b>Inside Corners</b>			
3/8	10.0	RO4-A100GRG-08	\$13.30
1/2	12.5	RO4-A125GRG-08	\$13.30



Height (in)	Height (mm)	Item Number	Price Each
<b>Length: 8' 2-1/2" (2.5 m)</b>			
3/8	10.0	RO4-A100STG-01	\$39.30
1/2	12.5	RO4-A125STG-01	\$40.14
<b>Length: 10' (3.0 m)</b>			
3/8	10.0	RO4-A100STG-02	\$49.14
<b>Outside Corners</b>			
3/8	10.0	RO4-A100STG-04	\$13.30
1/2	12.5	RO4-A125STG-04	\$13.30

Height (in)	Height (mm)	Item Number	Price Each
<b>Inside Corners</b>			
3/8	10.0	RO4-A100STG-08	\$13.30
1/2	12.5	RO4-A125STG-08	\$13.30



ROUND EDGE PROFILES MADE OF TEXTURE COATED ALUMINUM  
with corner pieces

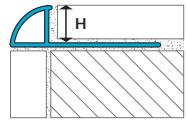

Height (in)	Height (mm)	Item Number	Price Each
<b>Length: 8' 2-1/2" (2.5 m)</b>			
5/16	8.0	R04-A080ANW-01	\$38.07
3/8	10.0	R04-A100ANW-01	\$39.30
1/2	12.5	R04-A125ANW-01	\$40.14
<b>Length: 10' (3.0 m)</b>			
5/16	8.0	R04-A080ANW-02	\$47.59
3/8	10.0	R04-A100ANW-02	\$49.14
1/2	12.5	R04-A125ANW-02	\$50.19

Height (in)	Height (mm)	Item Number	Price Each
<b>Outside Corners</b>			
5/16	8.0	R04-A080ANW-04	\$13.30
3/8	10.0	R04-A100ANW-04	\$13.30
1/2	12.5	R04-A125ANW-04	\$13.30

Height (in)	Height (mm)	Item Number	Price Each
<b>Inside Corners</b>			
5/16	8.0	R04-A080ANW-08	\$13.30
3/8	10.0	R04-A100ANW-08	\$13.30
1/2	12.5	R04-A125ANW-08	\$13.30

ANTIQUE WHITE



Height (in)	Height (mm)	Item Number	Price Each
<b>Length: 8' 2-1/2" (2.5 m)</b>			
5/16	8.0	R04-A080DKH-01	\$38.07
3/8	10.0	R04-A100DKH-01	\$39.30
1/2	12.5	R04-A125DKH-01	\$40.14
<b>Length: 10' (3.0 m)</b>			
5/16	8.0	R04-A080DKH-02	\$47.59
3/8	10.0	R04-A100DKH-02	\$49.14
1/2	12.5	R04-A125DKH-02	\$50.19

Height (in)	Height (mm)	Item Number	Price Each
<b>Outside Corners</b>			
5/16	8.0	R04-A080DKH-04	\$13.30
3/8	10.0	R04-A100DKH-04	\$13.30
1/2	12.5	R04-A125DKH-04	\$13.30

Height (in)	Height (mm)	Item Number	Price Each
<b>Inside Corners</b>			
5/16	8.0	R04-A080DKH-08	\$13.30
3/8	10.0	R04-A100DKH-08	\$13.30
1/2	12.5	R04-A125DKH-08	\$13.30

DESERT KHAKI



**ROUND EDGE PROFILES MADE OF TEXTURE COATED ALUMINUM**  
with corner pieces

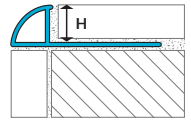

Height (in)	Height (mm)	Item Number	Price Each
<b>Length: 8' 2-1/2" (2.5 m)</b>			
5/16	8.0	R04-A080CBR-01	\$38.07
3/8	10.0	R04-A100CBR-01	\$39.30
1/2	12.5	R04-A125CBR-01	\$40.14
<b>Length: 10' (3.0 m)</b>			
5/16	8.0	R04-A080CBR-02	\$47.59
3/8	10.0	R04-A100CBR-02	\$49.14
1/2	12.5	R04-A125CBR-02	\$50.19

Height (in)	Height (mm)	Item Number	Price Each
<b>Outside Corners</b>			
5/16	8.0	R04-A080CBR-04	\$13.30
3/8	10.0	R04-A100CBR-04	\$13.30
1/2	12.5	R04-A125CBR-04	\$13.30

Height (in)	Height (mm)	Item Number	Price Each
<b>Inside Corners</b>			
5/16	8.0	R04-A080CBR-08	\$13.30
3/8	10.0	R04-A100CBR-08	\$13.30
1/2	12.5	R04-A125CBR-08	\$13.30

CHESTNUT BROWN



Height (in)	Height (mm)	Item Number	Price Each
<b>Length: 8' 2-1/2" (2.5 m)</b>			
5/16	8.0	R04-A080MOC-01	\$38.07
3/8	10.0	R04-A100MOC-01	\$39.30
1/2	12.5	R04-A125MOC-01	\$40.14
<b>Length: 10' (3.0 m)</b>			
5/16	8.0	R04-A080MOC-02	\$47.59
3/8	10.0	R04-A100MOC-02	\$49.14
1/2	12.5	R04-A125MOC-02	\$50.19

Height (in)	Height (mm)	Item Number	Price Each
<b>Outside Corners</b>			
5/16	8.0	R04-A080MOC-04	\$13.30
3/8	10.0	R04-A100MOC-04	\$13.30
1/2	12.5	R04-A125MOC-04	\$13.30

Height (in)	Height (mm)	Item Number	Price Each
<b>Inside Corners</b>			
5/16	8.0	R04-A080MOC-08	\$13.30
3/8	10.0	R04-A100MOC-08	\$13.30
1/2	12.5	R04-A125MOC-08	\$13.30

MOCHA



ROUND EDGE PROFILES MADE OF TEXTURE COATED ALUMINUM

with corner pieces

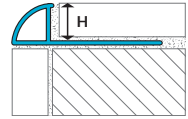

Height (in)	Height (mm)	Item Number	Price Each
<b>Length: 8' 2-1/2" (2.5 m)</b>			
5/16	8.0	RO4-A080DUG-01	\$38.07
3/8	10.0	RO4-A100DUG-01	\$39.30
1/2	12.5	RO4-A125DUG-01	\$40.14
<b>Length: 10' (3.0 m)</b>			
3/8	10.0	RO4-A100DUG-02	\$49.14
1/2	12.5	RO4-A125DUG-02	\$50.19

Height (in)	Height (mm)	Item Number	Price Each
<b>Outside Corners</b>			
5/16	8.0	RO4-A080DUG-04	\$13.30
3/8	10.0	RO4-A100DUG-04	\$13.30
1/2	12.5	RO4-A125DUG-04	\$13.30

Height (in)	Height (mm)	Item Number	Price Each
<b>Inside Corners</b>			
5/16	8.0	RO4-A080DUG-08	\$13.30
3/8	10.0	RO4-A100DUG-08	\$13.30
1/2	12.5	RO4-A125DUG-08	\$13.30

DUSTY GREY

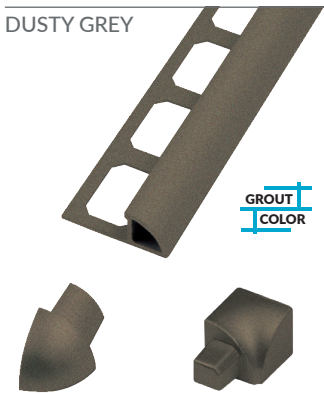

Height (in)	Height (mm)	Item Number	Price Each
<b>Length: 8' 2-1/2" (2.5 m)</b>			
5/16	8.0	RO4-A080RAV-01	\$38.07
3/8	10.0	RO4-A100RAV-01	\$39.30
1/2	12.5	RO4-A125RAV-01	\$40.14
<b>Length: 10' (3.0 m)</b>			
5/16	8.0	RO4-A080RAV-02	\$47.59
3/8	10.0	RO4-A100RAV-02	\$49.14
1/2	12.5	RO4-A125RAV-02	\$50.19

Height (in)	Height (mm)	Item Number	Price Each
<b>Outside Corners</b>			
5/16	8.0	RO4-A080RAV-04	\$13.30
3/8	10.0	RO4-A100RAV-04	\$13.30
1/2	12.5	RO4-A125RAV-04	\$13.30

Height (in)	Height (mm)	Item Number	Price Each
<b>Inside Corners</b>			
5/16	8.0	RO4-A080RAV-08	\$13.30
3/8	10.0	RO4-A100RAV-08	\$13.30
1/2	12.5	RO4-A125RAV-08	\$13.30

RAVEN



Height (in)	Height (mm)	Item Number	Price Each
<b>Length: 8' 2-1/2" (2.5 m)</b>			
3/8	10.0	RO4-A100MBL-01	\$31.45
1/2	12.5	RO4-A125MBL-01	\$32.11
<b>Length: 10' (3.0 m)</b>			
3/8	10.0	RO4-A100MBL-02	\$39.30

Height (in)	Height (mm)	Item Number	Price Each
<b>Outside Corners</b>			
3/8	10.0	RO4-A100MBL-04	\$10.32
1/2	12.5	RO4-A125MBL-04	\$10.32

Height (in)	Height (mm)	Item Number	Price Each
<b>Inside Corners</b>			
3/8	10.0	RO4-A100MBL-08	\$10.32
1/2	12.5	RO4-A125MBL-08	\$10.32

MATTE BLACK



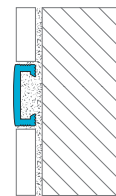

**DECORATIVE BORDER PROFILES MADE OF ANODIZED ALUMINUM**

visible surface: 1" (25 mm), installation depth: 5/16" (8 mm)

Height (in)	Height (mm)	Item Number	Price Each
Length: 8' 2-1/2" (2.5 m)			
1	25.0	DB1-A250SAT-01	\$24.58

SATIN



Height (in)	Height (mm)	Item Number	Price Each
Length: 8' 2-1/2" (2.5 m)			
1	25.0	DB1-A250PCR-01	\$33.83

POLISHED CHROME



Height (in)	Height (mm)	Item Number	Price Each
Length: 8' 2-1/2" (2.5 m)			
1	25.0	DB1-A250BCR-01	\$38.75

BRUSHED CHROME

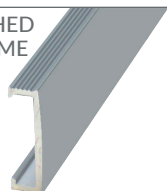

Height (in)	Height (mm)	Item Number	Price Each
Length: 8' 2-1/2" (2.5 m)			
1	25.0	DB1-A250SNI-01	\$25.81

SATIN NICKEL

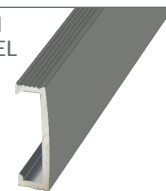

Height (in)	Height (mm)	Item Number	Price Each
Length: 8' 2-1/2" (2.5 m)			
1	25.0	DB1-A250BNI-01	\$39.96

BRUSHED NICKEL

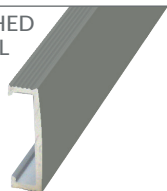

Height (in)	Height (mm)	Item Number	Price Each
Length: 8' 2-1/2" (2.5 m)			
1	25.0	DB1-A250PNI-01	\$35.04

POLISHED NICKEL



Height (in)	Height (mm)	Item Number	Price Each
Length: 8' 2-1/2" (2.5 m)			
1	25.0	DB1-A250SBR-01	\$24.58

SATIN BRASS

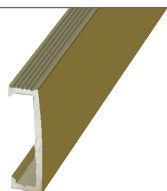

Height (in)	Height (mm)	Item Number	Price Each
Length: 8' 2-1/2" (2.5 m)			
1	25.0	DB1-A250BBR-01	\$38.75

BRUSHED BRASS

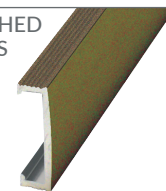

Height (in)	Height (mm)	Item Number	Price Each
Length: 8' 2-1/2" (2.5 m)			
1	25.0	DB1-A250BCU-01	\$39.96

BRUSHED COPPER

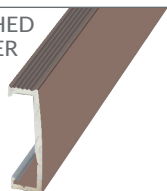

COVE PROFILES MADE OF ANODIZED ALUMINUM

two-sided connection

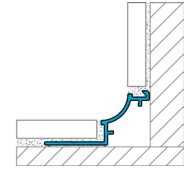

Height (in)	Height (mm)	Item Number	Price Each
<b>Length: 8' 2-1/2" (2.5 m)</b>			
5/16	8.0	CO2-A080SAT-01	\$27.43
3/8	10.0	CO2-A100SAT-01	\$28.56
15/32	12.0	CO2-A120SAT-01	\$28.67
1/2	12.5	CO2-A125SAT-01	\$29.86

SATIN

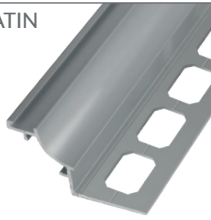

Height (in)	Height (mm)	Item Number	Price Each
<b>Outside Corners</b>			
Fits all sizes		CO2-AXXSAT-04	\$24.05
<b>Inside Corners</b>			
Fits all sizes		CO2-AXXSAT-08	\$24.05
<b>End Cap</b>			
Fits all sizes		CO2-AXXSAT-15	\$14.42
<b>Connector</b>			
Fits all sizes		CO2-AXXXXX-14	\$4.07

ACCESSORIES

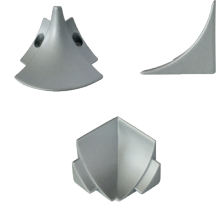

Height (in)	Height (mm)	Item Number	Price Each
<b>Length: 8' 2-1/2" (2.5 m)</b>			
3/8	10.0	CO2-A100SNI-01	\$32.90
1/2	12.5	CO2-A125SNI-01	\$34.22

SATIN NICKEL

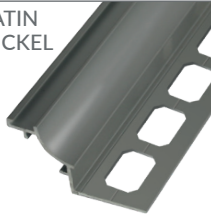

Height (in)	Height (mm)	Item Number	Price Each
<b>Length: 8' 2-1/2" (2.5 m)</b>			
3/8	10.0	CO2-A100BNI-01	\$46.89
1/2	12.5	CO2-A125BNI-01	\$48.20

BRUSHED NICKEL



Height (in)	Height (mm)	Item Number	Price Each
<b>Length: 8' 2-1/2" (2.5 m)</b>			
5/16	8.0	CO2-A080PCR-01	\$47.52
15/32	12.0	CO2-A120PCR-01	\$49.60

POLISHED CHROME

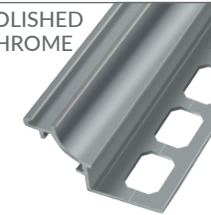

Height (in)	Height (mm)	Item Number	Price Each
<b>Length: 8' 2-1/2" (2.5 m)</b>			
3/8	10.0	CO2-A100BCR-01	\$43.70
1/2	12.5	CO2-A125BCR-01	\$45.00

BRUSHED CHROME

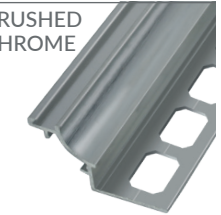

COVE PROFILES MADE OF COLOR COATED ALUMINUM

two-sided connection

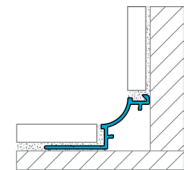

Height (in)	Height (mm)	Item Number	Price Each
<b>Length: 8' 2-1/2" (2.5 m)</b>			
5/16	8.0	CO2-A080BWH-01	\$28.80
15/32	12.0	CO2-A120BWH-01ztt	\$30.10

BRILLIANT WHITE



T-SHAPE PROFILES MADE OF ALUMINUM

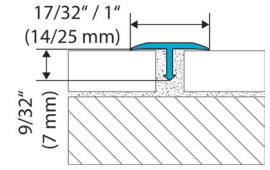

Height (in)	Height (mm)	Item Number	Price Each
Length: 8' 2-1/2" (2.5 m)			
17/32	14.0	TS1-A147NAT-01	\$10.37
1	25.0	TS1-A259NAT-01	\$16.76

NATURAL



T-SHAPE PROFILES MADE OF ANODIZED ALUMINUM

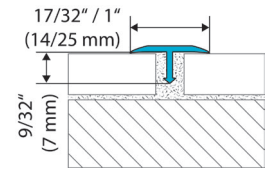

Height (in)	Height (mm)	Item Number	Price Each
Length: 8' 2-1/2" (2.5 m)			
17/32	14.0	TS1-A147SAT-01	\$10.92
1	25.0	TS1-A259SAT-01	\$17.64

SATIN



Height (in)	Height (mm)	Item Number	Price Each
Length: 8' 2-1/2" (2.5 m)			
17/32	14.0	TS1-A147SNI-01	\$12.77
1	25.0	TS1-A259SNI-01	\$21.24

SATIN NICKEL



Height (in)	Height (mm)	Item Number	Price Each
Length: 8' 2-1/2" (2.5 m)			
17/32	14.0	TS1-A147SBR-01	\$11.80
1	25.0	TS1-A259SBR-01	\$17.96

SATIN BRASS



## STAIR NOSING PROFILES / TRANSITION PROFILES

PAGE 40 - 43





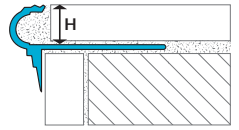

## STAIR NOSING PROFILES MADE OF ANODIZED ALUMINUM

with Florentine design

Height (in)	Height (mm)	Item Number	Price Each
<b>Length: 8' 2-1/2" (2.5 m)</b>			
11/32	9.0	SN1-A090SAT-01	\$26.75
7/16	11.0	SN1-A110SAT-01	\$27.31

SATIN



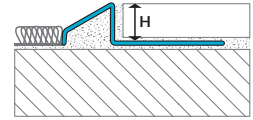

TRANSITION AND COMPENSATION PROFILES MADE OF STAINLESS STEEL 304

Height (in)	Height (mm)	Item Number	Price Each
<b>Length: 8' 2-1/2" (2.5 m)</b>			
5/16	8.0	TR1-E080GLO-01	\$39.33
3/8	10.0	TR1-E100GLO-01	\$43.01
1/2	12.5	TR1-E125GLO-01	\$47.72

GLOSS



Height (in)	Height (mm)	Item Number	Price Each
<b>Length: 8' 2-1/2" (2.5 m)</b>			
5/16	8.0	TR1-E080BRU-01	\$60.73
3/8	10.0	TR1-E100BRU-01	\$64.52
1/2	12.5	TR1-E125BRU-01	\$69.43

BRUSHED



TRANSITION AND COMPENSATION PROFILES MADE OF ANODIZED ALUMINUM

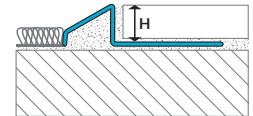

Height (in)	Height (mm)	Item Number	Price Each
<b>Length: 8' 2-1/2" (2.5 m)</b>			
5/16	8.0	TR1-A080SAT-01	\$17.01
3/8	10.0	TR1-A100SAT-01	\$17.88
1/2	12.5	TR1-A125SAT-01	\$23.73

SATIN

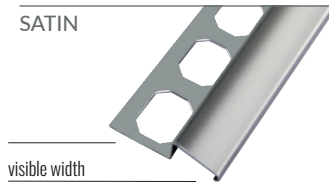

Height (in)	Height (mm)	Item Number	Price Each
<b>Length: 8' 2-1/2" (2.5 m)</b>			
3/8	10.0	TR1-A100ABB-01	\$33.15

ANTIQU  
BRUSHED  
BRONZE



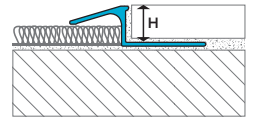

## TRANSITION AND COMPENSATION PROFILES MADE OF ANODIZED ALUMINUM

Height (in)	Height (mm)	Item Number	Price Each
<b>Length: 8' 2-1/2" (2.5 m)</b>			
5/16	8.0	TR2-A100SAT-01	\$18.86
3/8	10.0	TR2-A125SAT-01	\$24.30
1/2	12.5	TR2-A080SAT-01	\$17.64

SATIN





SKIRTING PROFILES

PAGE 44 - 45

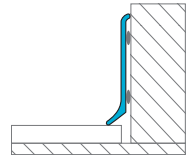

SKIRTING PROFILES MADE OF ANODIZED ALUMINUM

with accessories/corners

Height (in)	Height (mm)	Item Number	Price Each
Length: 8' 2-1/2" (2.5 m)			
2-3/8	60.0	SK1-A060SAT-01	\$25.14
3-1/8	80.0	SK1-A080SAT-01	\$30.73

Height (in)	Height (mm)	Item Number	Price Each
Outside Corners			
2-3/8	60.0	SK1-A060SAT-04	\$9.19
3-1/8	80.0	SK1-A080SAT-04	\$9.19

Height (in)	Height (mm)	Item Number	Price Each
Inside Corners			
2-3/8	60.0	SK1-A060SAT-08	\$9.19
3-1/8	80.0	SK1-A080SAT-08	\$9.19

SATIN



OUTSIDE CORNERS



INSIDE CORNERS



Height (in)	Height (mm)	Item Number	Price Each
Length: 8' 2-1/2" (2.5 m)			
2-3/8	60.0	SK1-A060SNI-01	\$25.14
3-1/8	80.0	SK1-A080SNI-01	\$30.73

Height (in)	Height (mm)	Item Number	Price Each
Outside Corners			
2-3/8	60.0	SK1-A060SNI-04	\$9.19
3-1/8	80.0	SK1-A080SNI-04	\$9.19

Height (in)	Height (mm)	Item Number	Price Each
Inside Corners			
2-3/8	60.0	SK1-A060SNI-08	\$9.19
3-1/8	80.0	SK1-A080SNI-08	\$9.19

SATIN NICKEL

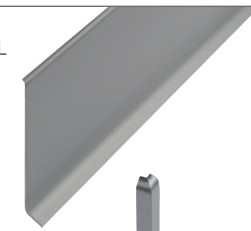

OUTSIDE CORNERS



INSIDE CORNERS



Height (in)	Height (mm)	Item Number	Price Each
Length: 8' 2-1/2" (2.5 m)			
2-3/8	60.0	SK1-A060BSL-01	\$77.73
3-1/8	80.0	SK1-A080BSL-01	\$101.96

Height (in)	Height (mm)	Item Number	Price Each
Outside Corners			
2-3/8	60.0	SK1-A060BSL-04	\$9.19
3-1/8	80.0	SK1-A080BSL-04	\$9.19

Height (in)	Height (mm)	Item Number	Price Each
Inside Corners			
2-3/8	60.0	SK1-A060BSL-08	\$9.19
3-1/8	80.0	SK1-A080BSL-08	\$9.19

BRUSHED STAINLESS STEEL



OUTSIDE CORNERS



INSIDE CORNERS



## EXPANSION JOINT PROFILES

PAGE 46 - 49



**EXPANSION JOINT PROFILES MADE OF STAINLESS STEEL 304**

For thin bed applications. EPDM infill, visible widths:  
 5/16" (8 mm), (heights 1/8" - 9/16") / 11/32" (9 mm), (heights 43/64" - 1-3/16")

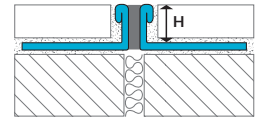

Height (in)	Height (mm)	Item Number	Price Each
<b>Length: 8' 2-1/2" (2.5 m)</b>			
1/8	3.0	EJ1-E030GRE-01	\$67.67
3/16	4.5	EJ1-E045GRE-01	\$69.06
1/4	6.0	EJ1-E060GRE-01	\$70.46
5/16	8.0	EJ1-E080GRE-01	\$71.90
3/8	10.0	EJ1-E100GRE-01	\$85.96
7/16	11.0	EJ1-E110GRE-01	\$88.10
1/2	12.5	EJ1-E125GRE-01	\$88.54
9/16	15.0	EJ1-E150GRE-01	\$91.36
3/4	20.0	EJ1-E200GRE-01	\$95.33
1	25.0	EJ1-E250GRE-01	\$101.93
1-3/16	30.0	EJ1-E300GRE-01	\$106.55

STAINLESS STEEL W/ GREY INFILL



Height (in)	Height (mm)	Item Number	Price Each
<b>Length: 8' 2-1/2" (2.5 m)</b>			
1/8	3.0	EJ1-E030LBE-01	\$67.67
3/16	4.5	EJ1-E045LBE-01	\$69.06
1/4	6.0	EJ1-E060LBE-01	\$70.46
5/16	8.0	EJ1-E080LBE-01	\$71.90
3/8	10.0	EJ1-E100LBE-01	\$85.96
7/16	11.0	EJ1-E110LBE-01	\$88.10
1/2	12.5	EJ1-E125LBE-01	\$88.54
9/16	15.0	EJ1-E150LBE-01	\$91.36
3/4	20.0	EJ1-E200LBE-01	\$95.33
1	25.0	EJ1-E250LBE-01	\$101.93
1-3/16	30.0	EJ1-E300LBE-01	\$106.55

STAINLESS STEEL W/ LIGHT BEIGE INFILL

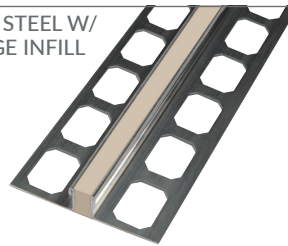

Height (in)	Height (mm)	Item Number	Price Each
<b>Length: 8' 2-1/2" (2.5 m)</b>			
1/8	3.0	EJ1-E030BLK-01	\$67.67
3/16	4.5	EJ1-E045BLK-01	\$69.06
1/4	6.0	EJ1-E060BLK-01	\$70.46
5/16	8.0	EJ1-E080BLK-01	\$71.90
3/8	10.0	EJ1-E100BLK-01	\$85.96
7/16	11.0	EJ1-E110BLK-01	\$88.10
1/2	12.5	EJ1-E125BLK-01	\$88.54
9/16	15.0	EJ1-E150BLK-01	\$91.36
3/4	20.0	EJ1-E200BLK-01	\$95.33
1	25.0	EJ1-E250BLK-01	\$101.93
1-3/16	30.0	EJ1-E300BLK-01	\$106.55

STAINLESS STEEL W/ BLACK INFILL



EXPANSION JOINT PROFILES MADE OF ALUMINUM

For thin bed applications. EPDM infill, visible width: 3/8" (10 mm)

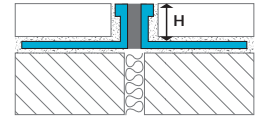

Height (in)	Height (mm)	Item Number	Price Each
<b>Length: 8' 2-1/2" (2.5 m)</b>			
1/8	3.0	EJ1-A030LBE-01	\$38.77
3/16	4.5	EJ1-A045LBE-01	\$39.56
1/4	6.0	EJ1-A060LBE-01	\$40.37
5/16	8.0	EJ1-A080LBE-01	\$41.19
3/8	10.0	EJ1-A100LBE-01	\$42.98
7/16	11.0	EJ1-A110LBE-01	\$44.94
1/2	12.5	EJ1-A125LBE-01	\$44.78
9/16	15.0	EJ1-A150LBE-01	\$46.79
5/8	16.0	EJ1-A160LBE-01	\$47.74
11/16	17.5	EJ1-A175LBE-01	\$48.12
3/4	20.0	EJ1-A200LBE-01	\$50.03
7/8	22.5	EJ1-A225LBE-01	\$52.53
1	25.0	EJ1-A250LBE-01	\$55.16
1-3/16	30.0	EJ1-A300LBE-01	\$57.92

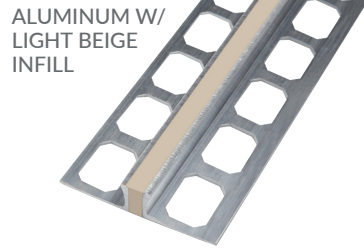

ALUMINUM W/  
LIGHT BEIGE  
INFILL

Height (in)	Height (mm)	Item Number	Price Each
<b>Length: 8' 2-1/2" (2.5 m)</b>			
1/8	3.0	EJ1-A030GRE-01	\$38.77
3/16	4.5	EJ1-A045GRE-01	\$39.56
1/4	6.0	EJ1-A060GRE-01	\$40.37
5/16	8.0	EJ1-A080GRE-01	\$41.19
3/8	10.0	EJ1-A100GRE-01	\$42.98
7/16	11.0	EJ1-A110GRE-01	\$44.94
1/2	12.5	EJ1-A125GRE-01	\$44.78
9/16	15.0	EJ1-A150GRE-01	\$46.79
5/8	16.0	EJ1-A160GRE-01	\$47.74
11/16	17.5	EJ1-A175GRE-01	\$48.12
3/4	20.0	EJ1-A200GRE-01	\$50.03
7/8	22.5	EJ1-A225GRE-01	\$52.53
1	25.0	EJ1-A250GRE-01	\$55.16
1-3/16	30.0	EJ1-A300GRE-01	\$57.92



ALUMINUM W/  
GREY INFILL

Height (in)	Height (mm)	Item Number	Price Each
<b>Length: 8' 2-1/2" (2.5 m)</b>			
1/8	3.0	EJ1-A030BLK-01	\$38.77
3/16	4.5	EJ1-A045BLK-01	\$39.56
1/4	6.0	EJ1-A060BLK-01	\$40.37
5/16	8.0	EJ1-A080BLK-01	\$41.19
3/8	10.0	EJ1-A100BLK-01	\$42.98
7/16	11.0	EJ1-A110BLK-01	\$44.94
1/2	12.5	EJ1-A125BLK-01	\$44.78
9/16	15.0	EJ1-A150BLK-01	\$46.79
5/8	16.0	EJ1-A160BLK-01	\$47.74
11/16	17.5	EJ1-A175BLK-01	\$48.12
3/4	20.0	EJ1-A200BLK-01	\$50.03
7/8	22.5	EJ1-A225BLK-01	\$52.53
1	25.0	EJ1-A250BLK-01	\$55.16
1-3/16	30.0	EJ1-A300BLK-01	\$57.92



ALUMINUM W/  
BLACK INFILL



**EXPANSION JOINT PROFILES MADE OF HARD-SOFT PVC**

For thin bed applications. Visible width: 5/16" (8 mm)

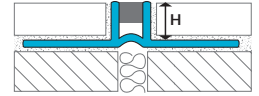

Height (in)	Height (mm)	Item Number	Price Each
<b>Length: 8' 2-1/2" (2.5 m)</b>			
1/4	6.0	EJ2-P060MUS-01	\$18.02
5/16	8.0	EJ2-P080MUS-01	\$18.49
3/8	10.0	EJ2-P100MUS-01	\$19.35
1/2	12.5	EJ2-P125MUS-01	\$19.35

MUSHROOM



Height (in)	Height (mm)	Item Number	Price Each
<b>Length: 8' 2-1/2" (2.5 m)</b>			
1/4	6.0	EJ2-P060GRE-01	\$18.02
5/16	8.0	EJ2-P080GRE-01	\$18.49
3/8	10.0	EJ2-P100GRE-01	\$19.35
1/2	12.5	EJ2-P125GRE-01	\$19.35
9/16	15.0	EJ2-P150GRE-01	\$22.42

GREY

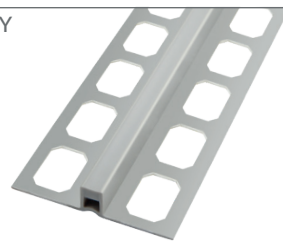

Height (in)	Height (mm)	Item Number	Price Each
<b>Length: 8' 2-1/2" (2.5 m)</b>			
1/4	6.0	EJ2-P080GGR-01	\$18.49
5/16	8.0	EJ2-P100GGR-01	\$19.35
3/8	10.0	EJ2-P125GGR-01	\$19.35
1/2	12.5	EJ2-P150GGR-01	\$22.42

GROUT GREY



Height (in)	Height (mm)	Item Number	Price Each
<b>Length: 8' 2-1/2" (2.5 m)</b>			
1/4	6.0	EJ2-P080RAV-01	\$18.49
5/16	8.0	EJ2-P100RAV-01	\$19.35
3/8	10.0	EJ2-P125RAV-01	\$19.35
1/2	12.5	EJ2-P150RAV-01	\$22.42

RAVEN

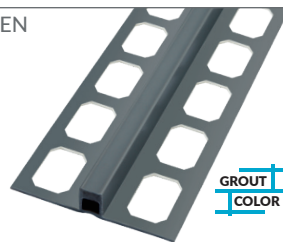

Height (in)	Height (mm)	Item Number	Price Each
<b>Length: 8' 2-1/2" (2.5 m)</b>			
1/4	6.0	EJ2-P060BLK-01	\$18.02
5/16	8.0	EJ2-P080BLK-01	\$18.49
3/8	10.0	EJ2-P100BLK-01	\$19.35
1/2	12.5	EJ2-P125BLK-01	\$19.35

BLACK



PART NUMBER EXPLANATION & CODES

Part Number Example  
**LS2-A100PCR-01**

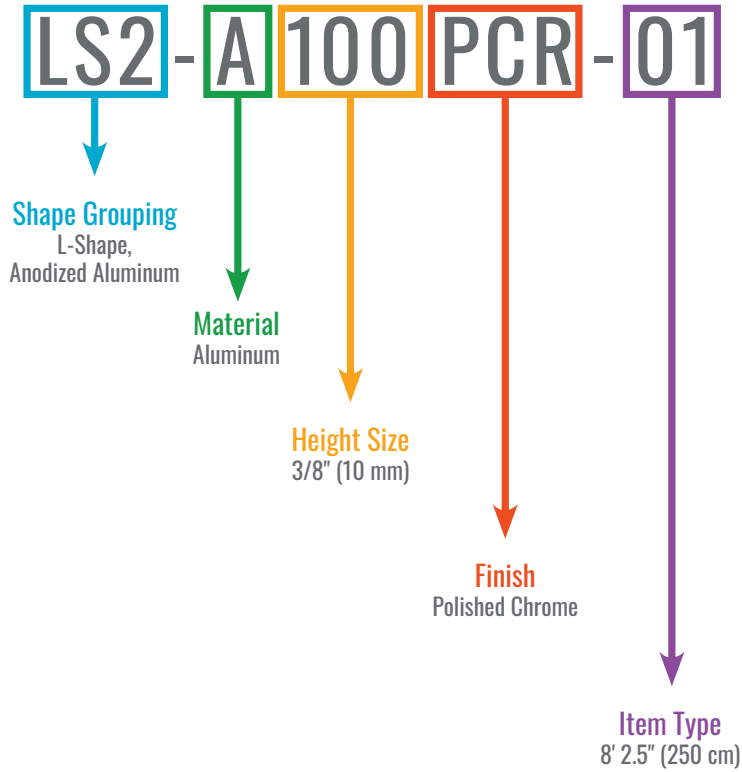

Code for Shape Type

Code	Shape Description
LS1	L-SHAPE EDGE PROFILE MADE OF ALUMINUM
LS2	L-SHAPE EDGE PROFILE MADE OF ANODIZED ALUMINUM
LS3	L-SHAPE EDGE PROFILE MADE OF COLOR COATED ALUMINUM
LS4	L-SHAPE EDGE PROFILE MADE OF TEXTURE COATED ALUMINUM
LS5	L-SHAPE EDGE PROFILE MADE OF STAINLESS STEEL
LS6	L-SHAPE EDGE PROFILE MADE OF COATED STAINLESS STEEL
LS8	L-SHAPE EDGE PROFILE MADE OF PVC
SQ2	SQUARE EDGE PROFILE MADE OF ANODIZED ALUMINUM
SQ3	SQUARE EDGE PROFILE MADE OF COLOR COATED ALUMINUM
SQ4	SQUARE EDGE PROFILE MADE OF TEXTURE COATED ALUMINUM
SQ5	SQUARE EDGE PROFILE MADE OF STAINLESS STEEL
RO2	ROUND EDGE PROFILE MADE OF ANODIZED ALUMINUM
RO3	ROUND EDGE PROFILE MADE OF COLOR COATED ALUMINUM
RO4	ROUND EDGE PROFILE MADE OF TEXTURE COATED ALUMINUM
RO5	ROUND EDGE PROFILE MADE OF STAINLESS STEEL
RO8	ROUND EDGE PROFILE MADE OF PVC
FP1	FINISHING PROFILES - STYLE 1 (135° INCLINE)
DB1	DECORATIVE BORDER PROFILES - STYLE 1 (1" WIDE)
CO2	COVE PROFILES - STYLE 2 (SINGLE MOUNTING LEG)
TS1	T-SHAPE PROFILES
SN1	STAIR NOSING PROFILE - STYLE 1 (FLORENTINE)
SK1	SKIRTING PROFILE
TR1	TRANSITION PROFILE - STYLE 1 (ABUTTING)
TR2	TRANSITION PROFILE - STYLE 2 (OVERHANGING)
EJ1	EXPANSION / MOVEMENT JOINT - STYLE 1 (7/16" WIDE)
EJ2	EXPANSION / MOVEMENT JOINT - STYLE 2 (3/16" WIDE)

PART NUMBER EXPLANATION & CODES

Code for Material Type

Code	Type of Material
A	ALUMINUM
E	STAINLESS STEEL 304
V	STAINLESS STEEL 316
M	BRASS
P	PVC

Code for Part Type

Code	Part Description
01	8'-2.5" PROFILE
02	10" PROFILE
04	OUT CORNER
08	IN CORNER
11	IN/OUT CORNER

Code for Finishes

Code	Type of Finish
ABB	ANTIQUÉ BRUSHED BRONZE
ALM	ALMOND
ANW	ANTIQUÉ WHITE
BBL	BRUSHED HIGH GLOSS BLACK
BBR	BRUSHED BRASS
BCR	BRUSHED CHROME
BCR	BRUSHED CHROME
BCU	BRUSHED COPPER
BGR	BRUSHED GRAPHITE
BLB	BLACK BROWN
BLK	BLACK
BNI	BRUSHED NICKEL
BRU	BRUSHED
BRW	BRIGHT WHITE
BWH	BRILLIANT WHITE
CBR	CHESTNUT BROWN
CRP	CHROME PLATED
DKH	DESERT KHAKI
DUG	DUSTY GREY
FRO	FROSTY
GGR	GROUT GREY
GLG	GOLD GLOSS
GLO	GLOSS
GRE	GREY
GRG	GREIGE
HGB	HIGH GLOSS BLACK
IVO	IVORY
MBL	MATTE BLACK
MBW	MATTE BRILLIANT WHITE
MHG	MANHATTAN GREY
MHG	CLASSIC GREY
MOC	MOCHA
MUS	MUSHROOM
NAT	NATURAL
PCR	POLISHED CHROME
PNI	POLISHED NICKEL
RAV	RAVEN
SAT	SATIN
SBR	SATIN BRASS
SNI	SATIN NICKEL
SPE	SAND PEBBLE
STG	STONE GREY

Code for Profile Height

Code	Inches	Millimeters
020	5/64"	2
025	3/32"	2.5
030	1/8"	3
035	1/8"	3.5
045	3/16"	4.5
060	1/4"	6
070	9/32"	7
080	5/16"	8
090	11/32"	9
100	3/8"	10
110	7/16"	11
120	15/32"	12
125	1/2"	12.5
140	17/32"	14
150	9/16"	15
160	5/8"	16
175	11/16"	17.5
185	23/32"	18.5
200	3/4"	20
210	13/16"	21
225	7/8"	22.5
250	1"	25
275	1-1/16"	27.5
300	1-3/16"	30
400	1-9/16"	40

## MAINTENANCE FOR TILE PROFILES

### STAINLESS STEEL 304

Withstands high mechanical stress. Stainless steel is particularly resistant to most chemical products, diluted acids and alkalis. Avoid contact with hydrochloric acid and unalloyed steel tools. When cut, stainless steel loses its rust resistance at the cutting edges, so separate rust protection should be applied. Cutting dust or sparks must be removed immediately (risk of flash rust). For special cases, stainless steel profiles are also available in 316L quality (even higher corrosion resistance than 304).



### ALUMINUM

Designed for medium mechanical strength. Sensitive to alkaline materials, e.g. this can lead to strong stains (oxidation spots) with fresh cement. Mortar and grout must always be wiped off immediately with plenty of clean water on visible surfaces. Once oxidation stains are present, they are very difficult to remove.



### ANODIZED ALUMINUM

Anodizing is a special, optically enhancing surfacing finish for aluminum profiles. Aluminum anodizing is available in the colors silver, gold, champagne and titanium. The anodized aluminum is sensitive to scratches and may discolor when combined with alkaline construction chemicals. Contact with fresh cement can lead to etching of the surface. Mortar and joint residues on visible surfaces must always be wiped off immediately with plenty of water. Once oxidation spots are present, they can hardly be removed. Only pH-neutral cleaning agents without abrasive components should be used.

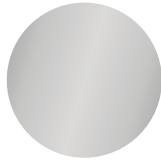

### COLOR AND TEXTURE COATED ALUMINUM

Coated using a special powder coating process. Thus harder and more durable than normal lacquering. UV-stable, good chemical resistance. Visible surfaces are sensitive to scratches. Use cleaning agents without abrasive components.



### BRASS

Designed for high mechanical strength. Brass oxidizes (patinizes) in air. When used in damp rooms or in conjunction with aggressive media, oxidation may increase or stains may form on visible parts. If necessary, brass profiles should be polished with special cleaning pastes to enhance their appearance. In the case of elastic connection joints, only neutrally crosslinking silicone should be used (risk of corrosion).



### PVC

Conditionally mechanically loadable, can only be used as edge protection against light impacts. Colored profiles are UV-stable under normal circumstances, but color differences may occur with constant UV irradiation. Insensitive to diluted acids and alkalis, e.g. chlorinated water. Resistant to fungi and bacteria.



### THIS APPLIES TO ALL MATERIALS

- When laying and grouting metal profiles and trims (aluminum, stainless steel and brass), adhesive and grouting materials must be removed immediately with fresh clear water and a soft, non-scratching sponge in order to avoid corrosion damage to the profiles.
- Do not use acidic (e.g. cement residue remover) or alkaline cleaning agents in combination with all metal profiles.
- Clean with clear water and dry a linen cloth.

## SERVICE TERMS

**Order Placement**

- Purchases for LATICRETE Profiles & Trims **must be placed on a separate purchase order** and cannot be combined on purchase orders with other LATICRETE products
- Purchase orders are accepted via EDI and E-Mail at [ProfileOrders@laticrete.com](mailto:ProfileOrders@laticrete.com)
- Purchase orders must contain the following:
  1. Purchase order number (required)
  2. Ship to full name, address and phone number
  3. Purchasing agent contact name and phone number
  4. LATICRETE item numbers, quantity, unit of measure & unit price
  5. Customer requested ship date if needed
  6. Detailed shipping instructions or special requests (ex. Next day air, lift gate)

**Payment Terms**

- Follow existing customer specific payment terms
- Past due accounts are subject to a 1.5% per month charge and will be placed on Collect on Delivery, or Collect in Advance.

**Delivery Terms**

- Orders returned to LATICRETE due to Customer's inability to accept or unload are subject to re-consignment, detention or holding fees to be charged back to the customer
- FOB LATICRETE Plant

**Special Order, Custom or AnyColor Items**

- A written purchase order is required
- Special order, Custom or AnyColor items are not cancelable or returnable
- Special Order, Custom or AnyColor orders ship directly to Distributor and may not be picked-up or drop shipped to end user.

**Shipping / Freight Charges**

- Standard Freight (Best Method)

Order Value	Up to \$500	\$500-\$999	\$1000-\$1999	\$2000-\$2999	>\$3000
<b>Standard Freight Fee</b>	\$50.00	\$75.00	\$100.00	\$125.00	Free

- Express Freight

Order Value	Up to \$500	\$500-\$999	\$1000-\$1999	\$2000-\$2999	>\$3000
<b>Next Day Freight Fee</b>	\$150.00	\$225.00	\$300.00	\$375.00	Priced at shipment
<b>2nd Day Freight Fee</b>	\$115.00	\$172.50	\$230.00	\$287.50	

## SERVICE TERMS CONTINUED

- LATICRETE Profiles & Trims ship with Standard Freight Fee (Best Method) unless otherwise noted on purchase order.
- Fees for Standard and Express Freight order value calculated based on published MSRP price
- LATICRETE Profiles & Trims will always ship via LATICRETE's preferred carrier prepaid freight. Freight is charged to the order accordingly.
- 10' profiles are not eligible for Standard Freight Fee Rates and are priced at the time of order placement
- Third-party and drop-ship orders are subject to an additional 10% handling fee
- Orders received by 11am will ship the same day
- Orders received after 11am will ship the following business day.
  - Shipping window start when order is released from any holds and are subject to product availability
  - Holidays and weekends are excluded from calculations
  - LATICRETE does not provide unloading equipment for shipments

## Changes to Purchase Orders Placed

- **Additions** of another item or quantity from existing purchase orders must be made to Customer Service via email at [ProfileOrders@laticrete.com](mailto:ProfileOrders@laticrete.com), additions will be processed as a separate order.
- **Removal/Cancellations** for same day shipments are not available.
- **Change requests** after purchase orders are processed are very limited and will not be possible after the order has been released to the shipping department. If possible, the ship date will be "reset" to ship the next business day.
  - May be subject to a 10% fee & carrier cancellation fee (carrier cancellation fees ranging from \$250-\$350) if picked, packed and/or scheduled.

## Backorders

- Communicated to customers via automatic electronic backorder notifications email
- Once the backorder becomes available, items will ship via freight prepaid.
- All backorders will remain open unless requested to cancel via email to the customer service department at [ProfileOrders@laticrete.com](mailto:ProfileOrders@laticrete.com)

## Claims / Returns

- LATICRETE shall not accept any returns unless specifically authorized in writing, which may be granted or withheld in LATICRETE's sole and absolute discretion.
- Claims submission about shortages, overages, or damages are required to be reported to Customer Service at [ProfileOrders@laticrete.com](mailto:ProfileOrders@laticrete.com) within 72 hours from receipt of shipment, any claims made after 72 hours of receipt will be denied.
- Claims require the following information:
  1. Purchase order number
  2. LATICRETE item #
  3. Quantity
  4. Reason for claim
    - a. **If damaged claim** – Must provide a supporting photo(s) of the damaged product, a copy of the delivery receipt noting damage, and must note damage on the carrier's copy of the delivery receipt.
    - b. **If shortage claim** – Receiver must sign the carrier's copy of the delivery receipt noting shortage of the product.
    - c. **If wrong product received** – Must provide a supporting photo(s) of the product received. The Customer Service Department will send you an RMA for the wrong product and enter a new order to be shipped as soon as possible.
  5. Any returns exceeding a total of \$5K are subject to review prior to the issuance of a return material authorization back to LATICRETE (RMA). Return authorizations expire if not returned within 30 days of issuance.

## SERVICE TERMS CONTINUED

6. Returns are subject to the lowest invoice price charged
  7. Customer is responsible for cost of freight on returns
- \*All Credits are subject to approval and will be issued as an A/R credit\**

## Return Guidelines

- Material returns require an RMA/RGA request for a return #
- Return request must contain the following information for processing:
  1. Purchase order number
  2. LATICRETE item number
  3. Quantity
  4. Reason for return
- No restocking fee for returns requested within 72 hours from invoice date
- 30% restocking fee applies for returns greater than 72 hours from invoice date
- 10% additional restocking fee applies if repackaging or rework is required
- 100% restocking fee applies for any return product that is identified as scrap
- Returns denied if:
  - Greater than 3 months from invoice date
  - Discontinued or obsolete material
  - Damaged or expired material
- Customer is responsible for cost of freight on returns
- No Credit or Refund will be given on any returned product that is identified as scrap

## Notifications

- Electronic Order Confirmation, Shipping & Backorder Acknowledgments are available, contact Customer Service at [ProfileOrders@laticrete.com](mailto:ProfileOrders@laticrete.com) to request or update your contact information
- Electronic invoices are available, contact Accounts Receivable at [LaticreteAR@laticrete.com](mailto:LaticreteAR@laticrete.com) to request or update existing contacts.
- For any of your customer service needs relating to LATICRETE Profiles & Trims, please contact customer service at [ProfileOrders@laticrete.com](mailto:ProfileOrders@laticrete.com)
- Terms and conditions are subject to change. Please contact your Sales or Customer Service Representative for the latest version.

## Compliance

You shall comply with all laws, rules, orders and regulations of governmental authorities applicable to the sale of product by LATICRETE to customer, including all applicable anti-corruption and export control laws of the United States and any other jurisdiction applicable to your activities.



For more information  
visit [laticrete.com/profiles](https://www.laticrete.com/profiles)